

LS

Single phase TEFV cage induction motors
Aluminium alloy frame - 0.06 to 5.5 kW
Technical catalogue

Single phase TEFV cage induction motors

Aluminium alloy frame

0.06 to 5.5 kW

The LEROY-SOMER range of single phase motors

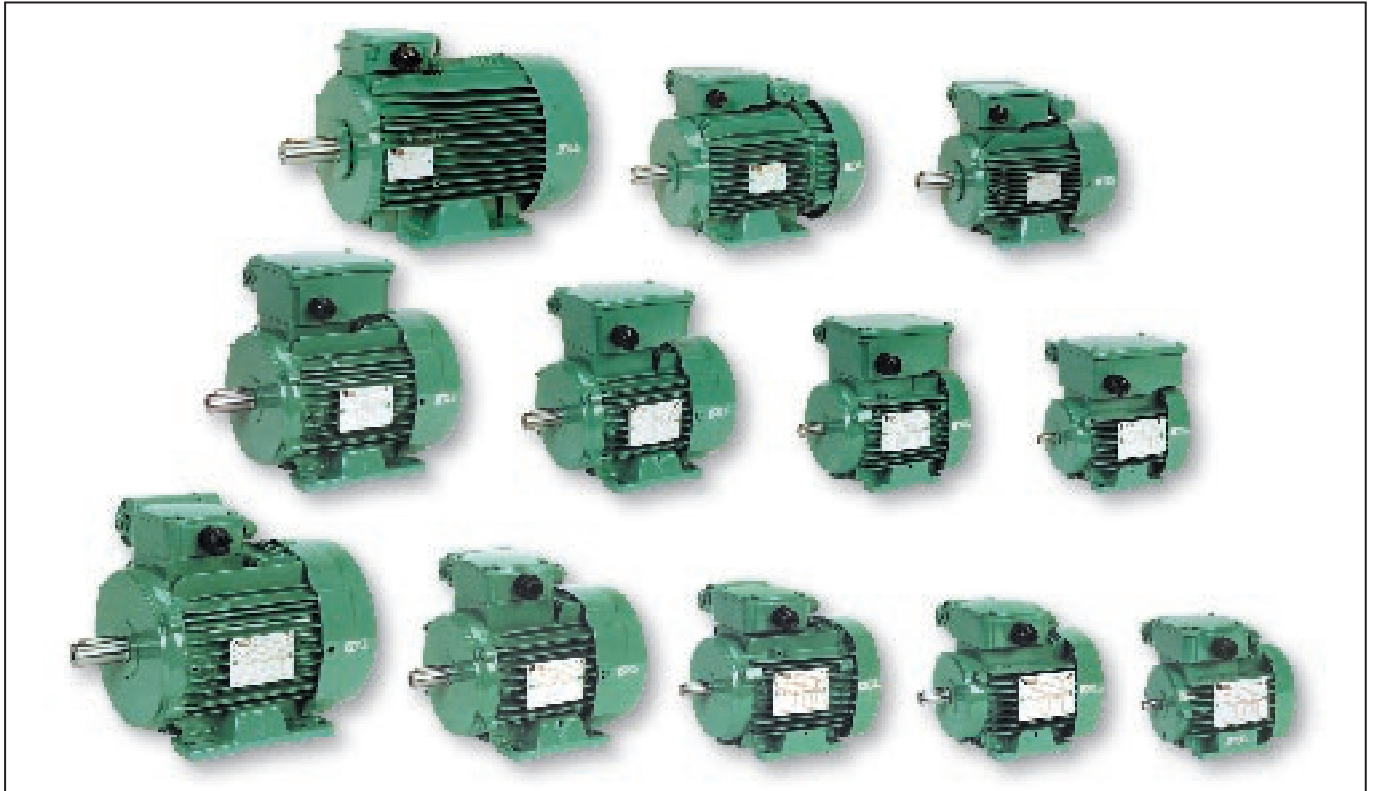

Other LEROY-SOMER motor ranges

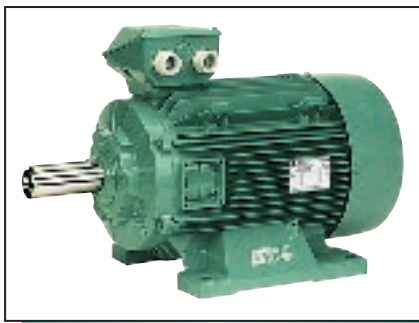

3-phase induction motor

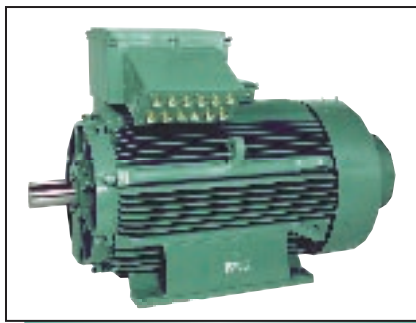

Cast iron motor



VARMECA variable speed motor

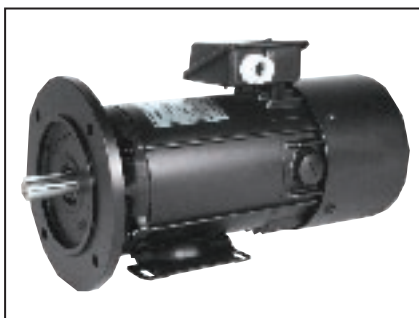

D.C. motor (drip-proof or enclosed)



Motor for variable speed drive systems

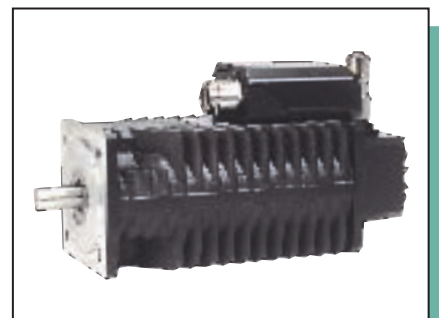

3-phase autosynchronous motor

Single phase TEFV cage induction motors

Aluminium alloy frame

0.06 to 5.5 kW

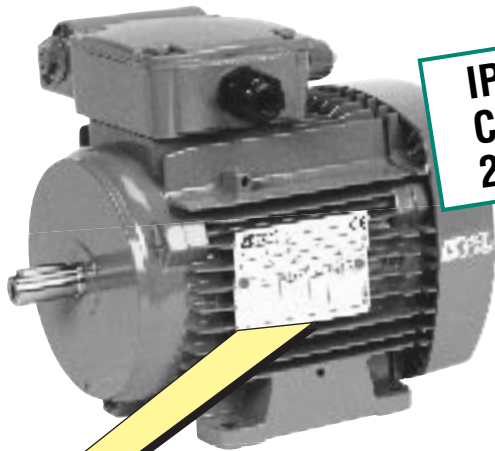

IP 55
Cl. F
230 V

Use the **complete motor designation** as shown below when placing your **order**.

Simply go through the complete designation step by step.

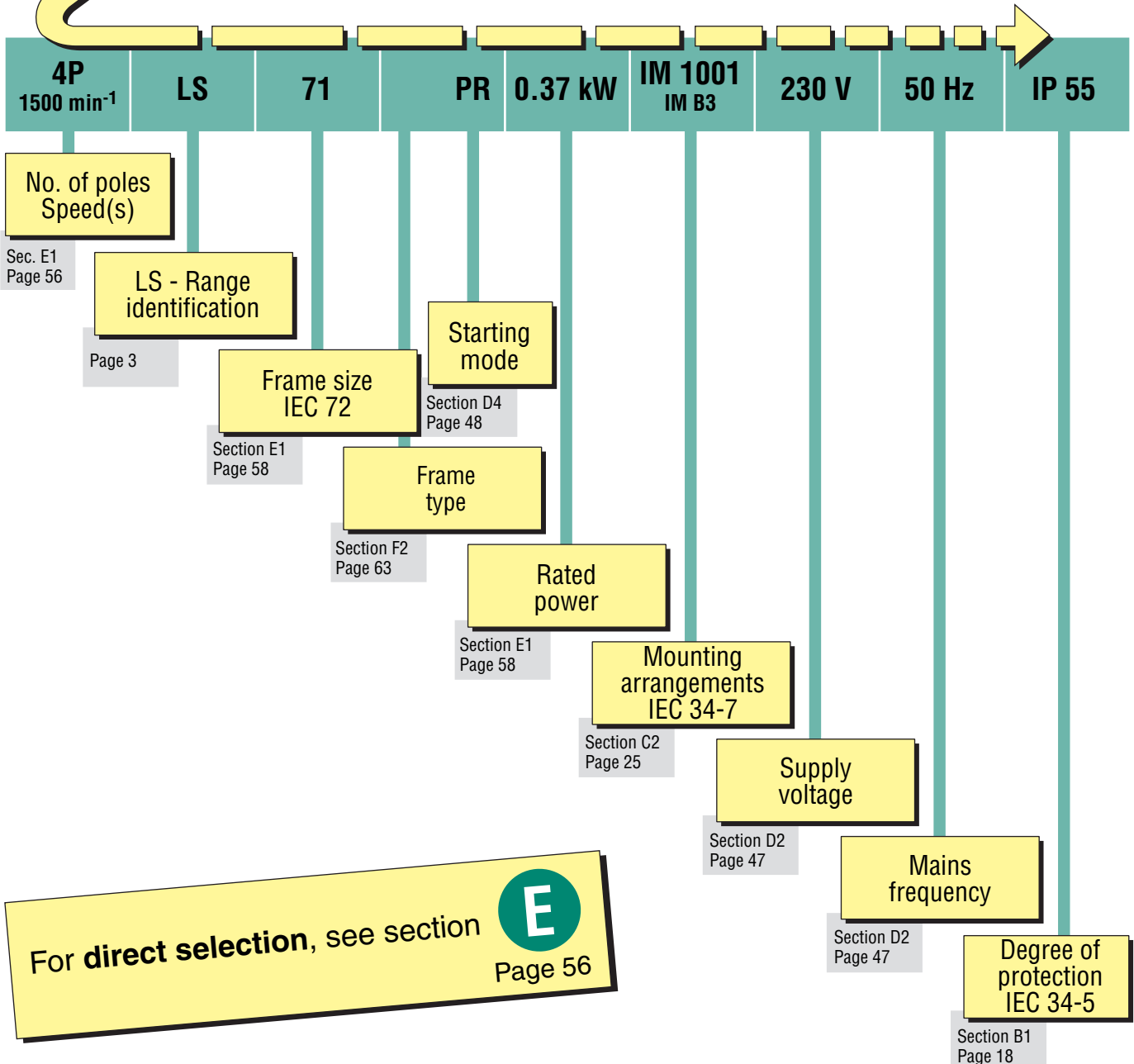

This document has been translated from the French version (Ref. 3173) which should be used for reference. LEROY-SOMER reserves the right to modify the design, technical specifications and dimensions of the products shown in this catalogue. The descriptions cannot in any way be considered contractual.

Single phase TEFV cage induction motors Aluminium alloy frame 0.06 to 5.5 kW

LEROY-SOMER, with its **international organisation** structured through **locally based technical and commercial centres**, is well equipped to provide direct support and assistance to the local market.

This assistance, reinforced by the **knowledge of local needs** and **regulations of its market**, guarantees an unequalled service to both home based and **exporting customers**.

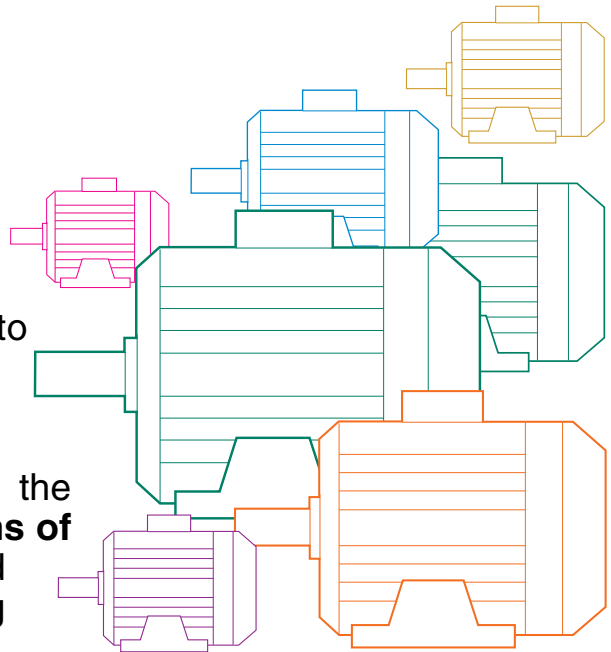

This **world wide local presence** allows greater flexibility to tailor availability to the **specific needs of our customers**, whether they be :

- **Immediate availability from stock**

- **Reduced lead times for adapted motors**

- **Scheduled or “just in time” deliveries**



Single phase TEFV cage induction motors

Aluminium alloy frame

0.06 to 5.5 kW

This catalogue gives full information about the **LEROY-SOMER LS single phase cage induction motor, 0.06 to 5.5 kW**

Designed to the latest European standards, this aluminium alloy frame motor satisfies most industrial requirements.

The selection chart can be used to find exactly the right motor for your application.

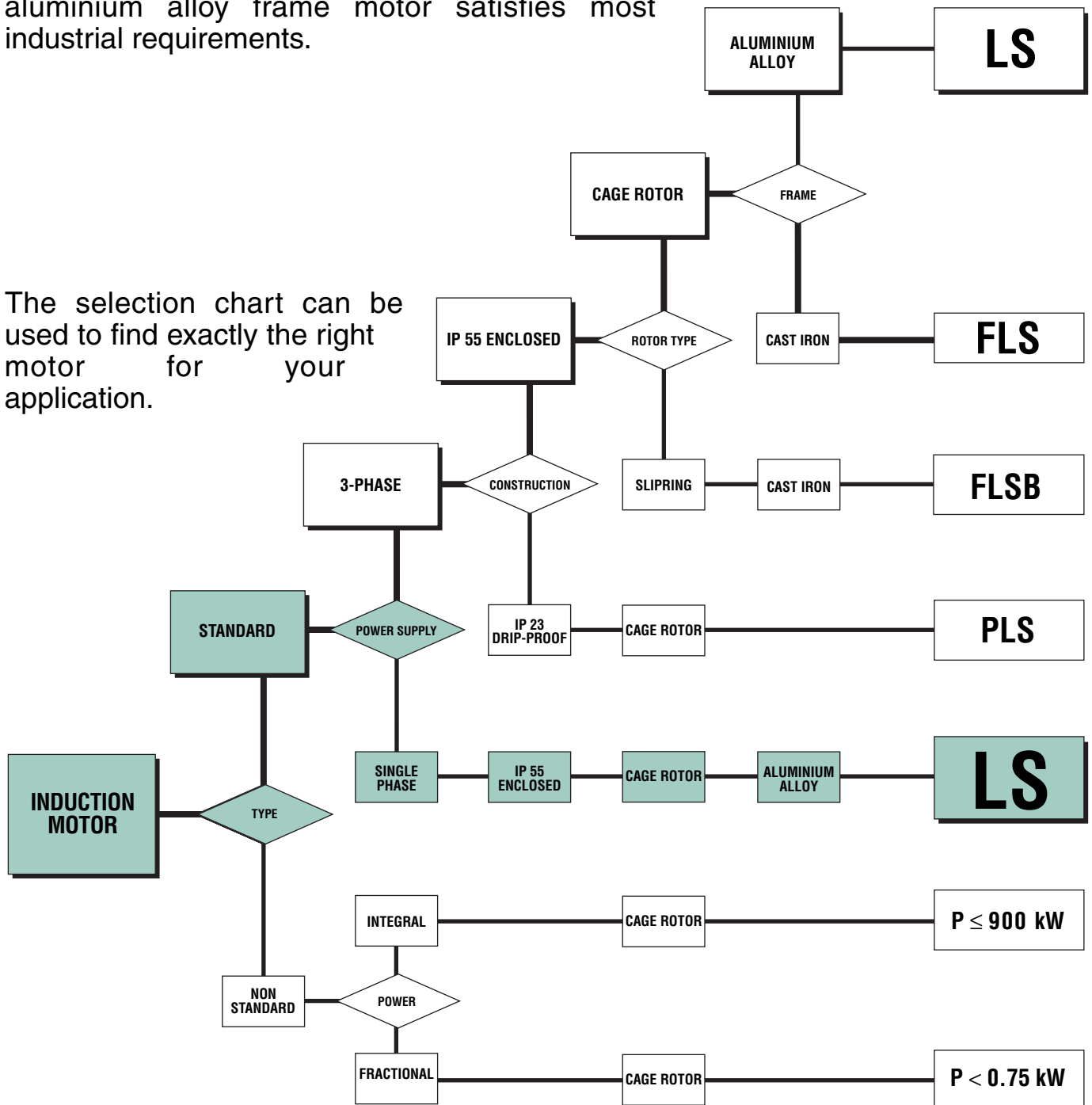

Single phase induction motors

Contents

	PAGES		PAGES
A - GENERAL INFORMATION	7	C - CONSTRUCTION	24
A1 - Quality assurance	7	C1 - Components	24
A2 - Standards and approvals	8	C2 - Mounting arrangements	25
A3 - Tolerances on main performance parameters	11	C2.1 - Mounting arrangements	25
A4 - Units of measurement and standard formulae	12	C2.2 - Mountings and positions	26
A4.1 - Electricity and electromagnetism	12	C3 - Bearings and lubrication	27
A4.2 - Thermodynamics	13	C3.1 - Bearings and bearing life - Definitions	27
A4.3 - Noise and vibration	13	C3.2 - Types of bearing and standard fitting arrangements	28
A4.4 - Dimensions	13	C3.3 - Lubrication and maintenance of bearings	34
A4.5 - Mechanics	14	C4 - Cooling	35
A5 - Unit conversions	15	C4.1 - Standard codes	36
A6 - Standard formulae used in electrical engineering	16	C4.2 - Ventilation	37
A6.1 - Mechanical formulae	16	C5 - Mains connection	38
A6.2 - Electrical formulae	17	C5.1 - Terminal box	38
B - ENVIRONMENT	18	C5.2 - Terminal box and cable gland table	39
B1 - Definition of "Index of Protection" (IP/IK)	18	C5.3 - Terminal blocks - Direction of rotation	40
B2 - Environmental limitations	19	C5.4 - Wiring diagrams	40
B2.1 - Normal operating conditions	19	C5.5 - Earth terminal	40
B2.2 - Normal storage conditions	19	C6 - Motor connections	41
B2.3 - Relative and absolute humidity	19	D - OPERATION	44
B2.4 - Drain holes	19	D1 - Duty cycle - Definitions	44
B2.5 - Drip cover	19	D2 - Supply voltage	47
B3 - Impregnation and enhanced protection	20	D2.1 - Regulations and standards	47
B3.1 - Normal atmospheric pressure	20	D3 - Insulation class	48
B3.2 - Influence of atmospheric pressure	21	D4 - Power - Torque - Efficiency - Power Factor - Cos φ	48
B4 - Heaters	22	D4.1 - Definitions	48
B4.1 - Space heaters	22	D4.2 - Influence of motor load on cos φ and efficiency	48
B5 - External finish	23	D4.3 - Torque - Speed characteristics	49
		D4.5 - Calculation of accelerating torque and starting time	50
		D4.6 - Rated power P_n in relation to duty cycle.....	51

LEROY-SOMER reserves the right to modify the design, technical specifications and dimensions of the products shown in this catalogue. The descriptions cannot in any way be considered contractual.

Single phase induction motors

Contents

	PAGES		PAGES
D5 - Noise and vibration	52	G - OPTIONAL FEATURES	68
D5.1 - Motor noise levels	52	G1 - Non-standard flanges	68
D5.2 - Motor vibration levels - Balancing	54	G2 - Drip covers	69
D6 - Performance	55	H - INSTALLATION and MAINTENANCE	70
D6.1 - Thermal protection	55	H1 - Voltage drop along cables (standard NFC 15 100)	70
E - SELECTION TABLES	56	H2 - Packaging weights and dimensions	71
E1 - Selection data : SINGLE SPEED	58	H3 - Position of lifting rings	72
2 poles - 3000 - 3600 min ⁻¹	58 - 59	H4 - Identification - Exploded views and parts list	73
4 poles - 1500 - 1800 min ⁻¹	60 - 61	H5 - Maintenance	78
6 poles - 1000 - 1200 min ⁻¹	60 - 61		
F - DIMENSIONS	62		
F1 - Dimensions of shaft extensions	62		
F2 - Foot mounted	63		
F3 - Foot and flange mounted	64		
F4 - Flange mounted	65		
F5 - Foot and face mounted	66		
F6 - Face mounted	67		
F7 - Electrical cabinet for LS 132	67		

Single phase induction motors

Index

	PAGES		PAGES
Altitude	19	Mains connections	38, 40
Ambient temperature	19	Mains voltage	47
Approvals	8-9	Maintenance	78
		Motor connections	41 to 43
Balancing	54	Mounting arrangements	24
Bearing lubrication	34	Multivoltage motors	47
Bearings	24, 27		
BSI	8	NEMA	8
		NFC	9
		Noise levels	52
Cable gland	39		
Cables	70	Operating positions	26
Construction	25		
Cooling	35	Packaging	71
Cos φ (Power Factor)	48	Paint	23
		Parts lists	74 to 75
Dimensions	62 to 67	Permissible axial load	29 to 31
DIN/VDE	8	Permissible radial load	32 to 33
Direction of rotation	40	Power	48
Drain holes	19	Power Factor	48
Drip covers	19, 69		
Duty cycles	44 to 46	Quality assurance	7
Earth terminals	40	Rotor	24
Efficiency	48		
EN	10	Selection tables	56 to 61
End shields	24	Serial number	73
Environment	19	Shaft loadings	29 to 33
Exploded views	74 to 75	Single-speed motors	56
		Standard bearing arrangements	28 to 33
Fan cover	24, 37	Standards	8
Flanges	64 to 67	Starting time	50
Formulae	16	Stator	24
Grease	34	Temperature rise	48
		Terminal blocks	40
Heaters	22	Terminal box	38
Housing	24	Thermal protection	55
Humidity	19	Tolerances	11
		Torque	48
Identification	73	Torque curves	49
IEC	8		
Impregnation	20	UL/CSA	9
Insulation class	48	Unit conversion	15
Intermittent duty cycles	51	Units	12
ISO 9001	7		
		Variable speed	76
JIS	8	Varmeca	76
		Ventilation	37
Key	54, 62	Vibration	52
		Vibration levels	54
Lubrication	34	Voltage drop	70
		Wiring diagrams	40

Single phase induction motors

General information

A1 - Quality assurance

Industrial concerns are having to cope with an ever more competitive environment. Productivity depends to a considerable degree on the right investment at the right time.

LEROY-SOMER has the answer, building motors to precise standards of quality.

When carrying out quality checks on a machine's performance, the first step is to **measure the level of customer satisfaction**.

Careful study of this information tells us which points need looking at, improving and monitoring.

From the moment you place your order with our administrative staff until the motor is up and running (after design studies, launch and production activities) we keep you informed and involved.

Our own procedures are constantly under review, using both "hoshin" production improvement programmes and improved engineering techniques.

All our staff are involved in both operational process analysis and continuous training programmes. These initiatives help them serve you better, and increased skills bring increased motivation.

At LEROY-SOMER, we think it vital for our customers to know the importance we attach to quality.

LEROY-SOMER has entrusted the certification of its expertise to various international organizations. Certification is granted by independent professional auditors, and recognises the high standards of the **company's quality assurance procedures**.

All activities resulting in the final version of the machine have therefore received official ISO 9001 accreditation. Products are also approved by official bodies who inspect their technical performance with regard to the various standards. This is a fundamental requirement for a company of international standing.



ATTESTATION





Single phase induction motors

General information

A2 - Standards and approvals

ORGANIZATION OF STANDARDS AUTHORITIES

International bodies :

Worldwide 	General standardization ISO International Standards Organization <div style="display: flex; justify-content: space-around; margin-top: 10px;"> <div style="border: 1px solid black; padding: 2px; font-size: 8px;">TC Technical Committees</div> <div style="border: 1px solid black; padding: 2px; font-size: 8px;">SC Sub- committees</div> <div style="border: 1px solid black; padding: 2px; font-size: 8px;">WG Working Groups</div> </div>	Electronics and Electrotechnical Certification IEC International Electrotechnical Commission <div style="display: flex; justify-content: space-around; margin-top: 10px;"> <div style="border: 1px solid black; padding: 2px; font-size: 8px;">TC Technical Committees</div> <div style="border: 1px solid black; padding: 2px; font-size: 8px;">SC Sub- committees</div> <div style="border: 1px solid black; padding: 2px; font-size: 8px;">WG Working Groups</div> </div>
Europe 	ECS / CEN European Committee for Standardization ECISS European Committee for Iron and Steel Standards <div style="border: 1px solid black; padding: 2px; font-size: 8px; margin-top: 10px; text-align: center;"> TC Technical Committees </div>	CENELEC European Committee for Electrotechnical Standardization <div style="display: flex; justify-content: space-around; margin-top: 10px;"> <div style="border: 1px solid black; padding: 2px; font-size: 8px;">TC Technical Committees</div> <div style="border: 1px solid black; padding: 2px; font-size: 8px;">SC Sub- committees</div> <div style="border: 1px solid black; padding: 2px; font-size: 8px;">AHG Ad-hoc Groups</div> </div>

Country	Initials	Name
AUSTRALIA	SAA	Standards Association of Australia
BELGIUM	IBN	Institut Belge de Normalisation
CIS (ex-USSR)	GOST	Gosudarstvenne Komitet Standartov
DENMARK	DS	Dansk Standardiseringsraad
FINLAND	SFS	Suomen Standardisoimisliitto
FRANCE	AFNOR including UTE	Association Française de Normalisation including : Union Technique de l'Electricité
GERMANY	DIN / VDE	Verband Deutscher Elektrotechniker
ITALY	CEI	Comitato Electrotechnico Italiano
JAPAN	JIS	Japanese Industrial Standard
NETHERLANDS	NNI	Nederlands Normalisatie - Instituut
NORWAY	NFS	Norges Standardiseringsforbund
SAUDI ARABIA	SASO	Saudi Arabian Standards Organization
SPAIN	UNE	Una Norma Española
SWEDEN	SIS	Standardiseringskommissionen I Sverige
SWITZERLAND	SEV or ASE	Schweizerischer Elektrotechnischer Verein
UNITED KINGDOM	BSI	British Standards Institution
USA	ANSI including NEMA	American National Standards Institute including : National Electrical Manufacturers

Single phase induction motors

General information

Approvals :

Certain countries recommend or insist on approval from national organizations.
Approved products must carry the recognized mark on their identification plates.

Country	Initials	Organization
USA	UL or FJ	Underwriters Laboratories
CANADA	CSA	Canadian Standards Association
etc...		

Approvals for LEROY-SOMER motors (versions derived from standard construction) :

Country	Initials	Certification No.	Application
CANADA	CSA	LR 57 008	Standard or adapted range
USA	FJ	E 68554	Insulation systems
SAUDI ARABIA	SASO	R 200835	Standard range

International and National Standard equivalents :

International reference standards		National Standard				
IEC	Title (summary)	FRANCE	GERMANY	U.K.	ITALY	SWITZERLAND
34-1	Ratings and operating characteristics	NFEN 60034-1 NEC 51 120 NEC 51 200	DIN/VDE 0530	BS 4999	CEI 2.3.VI.	SEV 3009
34-2	Determination of losses and efficiency	NFC 51 112		BS 4999		
34-5	Classification of degrees of protection	NFEN 60034-5	DIN/IEC 34-5	BS 4999	UNEL B 1781	
34-6	Cooling methods		DIN/IEC 34-6	BS 4999		
34-7	Mounting arrangements and assembly layouts	NFEN 60034-7	DIN/IEC 34-7	BS 4999		
34-8	Terminal markings and direction of rotation	NFC 51 118	DIN/VDE 0530 Teil 8	BS 4999		
34-9	Noise limits	NFEN 60034-9	DIN/VDE 0530 Teil 9	BS 4999		
72-1	Dimensions and output powers for machines of between 56 and 400 frame and for flanges of between 55 and 1080	NFC 51 104 NFC 51 105	DIN 748 (-) DIN 42672 DIN 42673 DIN 42631 DIN 42676 DIN 42677	BS 4999		
85	Evaluation and thermal classification of electrical insulation	NFC 26206	DIN/VDE 0530			SEV 3009

N.B. : DIN 748 tolerances do not conform to IEC 72.1

Single phase induction motors

General information

List of standards quoted in this catalogue

LS motors comply with the standards quoted in this catalogue

Reference	Date	International Standards
IEC 34-1	NF EN 60034-1	1996 Electrical rotating machines : ratings and operating characteristics
IEC 34-5	NF EN 60034-5	1991 Electrical rotating machines : classification of degrees of protection provided by casings
IEC 34-6	EN 60034-6	1991 Electrical rotating machines (except traction) : cooling methods
IEC 34-7	NF EN 60034-7	1995 Electrical rotating machines (except traction) : symbols for mounting positions and assembly layout
IEC 34-8	NFC 51 118	1990 Electrical rotating machines : terminal markings and direction of rotation
IEC 34-9	NF EN 60034-9	1995 Electrical rotating machines : noise limits
IEC 38		1994 IEC standard voltages
IEC 72-1		1991 Dimensions and power series for electrical rotating machines : designation of casings between 56 and 400 and flanges between 55 and 1080
IEC 85	NFC 26 206	1984 Evaluation and thermal classification of electrical insulation
IEC 529	EN 60529	1989 Degrees of protection provided by enclosures
IEC 721-2-1		1987 Classification of natural environmental conditions. Temperature and humidity
IEC 1000 2-1 and 2		1990 Electromagnetic compatibility (EMC) : environment
Guide 106 IEC		1989 Guidelines on the specification of environmental conditions for the determination of equipment operating characteristics
ISO 281		1990 Bearings - Basic dynamic loadings and nominal bearing life
ISO 1680-1 and 2	EN 21680-1 and 2	1986 Acoustics - Test code for measuring airborne noise emitted by electrical rotating machines: a method for establishing an expert opinion for free field conditions over a reflective surface
ISO 8821		1989 Mechanical vibration - Balancing. Conventions on shaft keys and related parts
	EN 50102	1992 Degree of protection provided by the electrical housing against extreme mechanical impacts

A

Single phase induction motors

General information

A3 - Tolerances on main performance parameters

Tolerances for electromechanical characteristics :

IEC 34-1 specifies standard tolerances for electromechanical characteristics.

Parameters	Tolerances
Efficiency machines $P \leq 50$ kW	- 15 % ($1 - \eta$)
Power factor ($\cos \varphi$)	-1/6 ($1 - \cos \varphi$) (min 0.02 - max 0.07)
Slip { machines $P < 1$ kW machines $P \geq 1$ kW	± 30 % ± 20 %
Starting torque	- 15 %, + 25 % of rated torque
Starting current	+ 20 %
Run-up torque	- 15 % of rated torque
Breakdown torque	- 10 % of rated torque $> 1.5 M_N$
Moment of inertia	± 10 %
Noise	+ 3 dB (A)
Vibration	+ 10 % of guaranteed classification

Tolerances and adjustments :

The standard tolerances shown below are applicable to the drawing dimensions given in our catalogues. They fully comply with IEC standard 72-1.

Dimension	Tolerances
Frame size $H < 250$	0, — 0.5 mm
Diameter \varnothing of shaft extension : - 11 to 28 mm - 32 to 48 mm	j6 k6
Diameter N of flange spigot :	j6 up to FF 500, js6 for FF 600 and over
Key width :	h9
Width of drive shaft keyway (normal keying)	N9
Key depth : - square section - rectangular section	h9 h 11
① <i>Eccentricity of shaft in flanged motors</i> (standard class) - diameter > 10 up to 18 mm - diameter > 18 up to 30 mm - diameter > 30 up to 50 mm	0.035 mm 0.040 mm 0.050 mm
② <i>Concentricity of spigot diameter</i> and ③ <i>perpendicularity of mating surface of flange in relation to shaft</i> (standard class) Flange (FF) or Faceplate (FT): - F 55 to F 115 - F 130 to F 265 - FF 300 to FF 500	0.08 mm 0.10 mm 0.125 mm

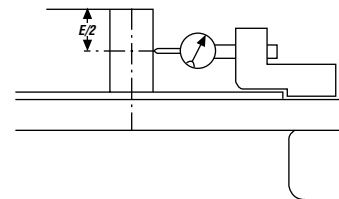

① *Eccentricity of shaft in flanged motors*

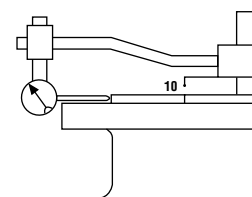

② *Concentricity of spigot diameter*

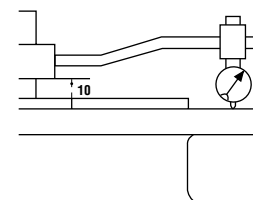

③ *Perpendicularity of mating surface of flange in relation to shaft*

Single phase induction motors

General information

A4 - Units of measurement and standard formulae

A4.1 - ELECTRICITY AND ELECTROMAGNETISM

Quantity				Units		Units and expressions not recommended
Name	French name	Symbol	Definition	SI	Non SI, but accepted	Conversion
Frequency	Fréquence Période	f	$f = \frac{1}{T}$	Hz (hertz)		
Electric current	Courant électrique (intensité de)	I		A (ampere)		
Electric potential	Potentiel électrique	V		V (volt)		
Voltage	Tension	U				
Electromotive force	Force électromotrice	E				
Phase angle	Déphasage	φ	$U = Um \cos \omega t$ $i = im \cos (\omega t - \varphi)$	rad	° degree	
Power factor	Facteur de puissance	$\cos \varphi$				
Reactance	Réactance	X	$Z = Z ^{j\varphi}$			j is defined as $j^2 = -1$ ω pulsation = $2 \pi \cdot f$
Resistance	Résistance	R	$= R + jX$	Ω (ohm)		
Impedance	Impédance	Z	$ Z = \sqrt{R^2 + X^2}$ $X = L\omega - \frac{1}{C\omega}$			
Inductance	Inductance propre (self)	L	$L = \frac{\Phi}{I}$	H (henry)		
Capacitance	Capacité	C	$C = \frac{Q}{V}$	F (farad)		
Quantity of electricity	Charge électrique, Quantité d'électricité	Q	$Q = \int I dt$	C (coulomb)	A.h 1 A.h = 3600 C	
Resistivity	Résistivité	ρ	$\rho = \frac{R \cdot S}{l}$	$\Omega \cdot m$		Ω / m
Conductance	Conductance	G	$G = \frac{1}{R}$	S (siemens)		$1/\Omega = 1S$
N° of turns (coil)	Nombre de tours, (spires) de l'enroulement	N				
N° of phases	Nombre de phases	m				
N° of pairs of poles	Nombre de paires de pôles	p				
Magnetic field	Champ magnétique	H		A/m		
Magnetic potential difference	Différence de potentiel magnétique	Um		A		The unit AT (ampere-turns) is incorrect because it treats "turn" as a physical unit
Magnetomotive force	Force magnétomotrice Solénation, courant totalisé	F, Fm H	$F = \phi H_s d_s$ $H = NI$			
Magnetic induction	Induction magnétique,	B		T (tesla) = Wb/m^2		(gauss) $1 G = 10^{-4} T$
Magnetic flux density	Densité de flux magnétique					
Magnetic flux	Flux magnétique, Flux d'induction magnétique	Φ	$\Phi = \int f_s B n ds$	Wb (weber)		(maxwell) $1 \text{ max} = 10^{-8} \text{ Wb}$
Magnetic vector potential	Potentiel vecteur magnétique	A		Wb/m		
Permeability	Perméabilité d'un milieu	$\mu = \mu_o \mu_r$	$B = \mu H$	H/m		
Permeability of vacuum	Perméabilité du vide	μ_o	$\mu_o = 4\pi \cdot 10^{-7} \text{ H/m}$			
Permittivity	Permittivité	$\epsilon = \epsilon_o \epsilon_r$	$\epsilon_o = \frac{1}{36 \pi \cdot 10^9} \text{ F/m}$	F/m		

Single phase induction motors

General information

A4.2 - THERMODYNAMICS

Quantity				Units		Units and expressions not recommended
Name	French name	Symbol	Definition	SI	Non SI, but accepted	Conversion
Temperature Thermodynamic	Température Thermodynamique	T		K (kelvin)	temperature Celsius, t , °C $T = t + 273.15$	°C : Degree Celsius t_C : temp. in °C t_F : temp. in °F f temperature Fahrenheit °F $t = \frac{f - 32}{1.8}$ $t_C = \frac{t_F - 32}{1.8}$
Temperature rise	Ecart de température	ΔT		K	°C	1 °C = 1 K
Thermal flux density	Densité de flux thermique	q, φ	$q = \frac{\Phi}{A}$	W/m ²		
Thermal conductivity	Conductivité thermique	λ		W/m.K		
Total heat transmission coefficient	Coefficient de transmission thermique global	K	$\varphi = K (Tr_2 - Tr_1)$	W/m ² .K		
Thermal capacity	Capacité thermique	C	$C = \frac{dQ}{dT}$	J/K		
Specific thermal capacity	Capacité thermique massique	c	$c = \frac{C}{m}$	J/kg.K		
Internal energy	Energie interne	U		J		

A4.3 - NOISE AND VIBRATION

Quantity				Units		Units and expressions not recommended
Name	French name	Symbol	Definition	SI	Non SI, but accepted	Conversion
Sound power level	Niveau de puissance acoustique	L_w	$L_w = 10 \lg (P/P_0)$ ($P_0 = 10^{-12} W$)	dB (decibel)		lg logarithm to base 10 lg10 = 1
Sound pressure level	Niveau de pression acoustique	L_p	$L_p = 20 \lg (P/P_0)$ ($P_0 = 2 \times 10^{-5} Pa$)	dB		

A4.4 - DIMENSIONS

Quantity				Units		Units and expressions not recommended
Name	French name	Symbol	Definition	SI	Non SI, but accepted	Conversion
Angle (plane angle)	Angle (angle plan)	$\alpha, \beta, \tau, \varphi$		rad	degree : ° minute : ' second : "	180° : π rad ≈ 3.14 rad
Length Width Height Radius	Longueur Largeur Hauteur Rayon Longueur curviligne	l b h r s		m (metre)	micrometre	cm, dm, dam, hm 1 inch = 1" = 25.4 mm 1 foot = 1' = 304.8 mm μm micron μ angström : A = 0.10 nm
Area	Aire, superficie	A, S		m ²		1 square inch = 6.45 10 ⁻⁴ m ²
Volume	Volume	V		m ³	litre : l liter : L	UK gallon = 4.546 10 ⁻³ m ³ US gallon = 3.785 10 ⁻³ m ³

Single phase induction motors

General information

A4.5 - MECHANICS

A

Quantity				Units		Units and expressions not recommended
Name	French name	Symbol	Definition	SI	Non SI, but accepted	Conversion
Time	Temps	t				
Time interval / duration	Intervalle de temps, durée			s (second)	minute : min hour : h day : d	Symbols ' and " are reserved for angles minute not written as mn
Period (duration of cycle)	Période (durée d'un cycle)	T				
Angular velocity	Vitesse angulaire	ω	$\omega = \frac{d\varphi}{dt}$	rad/s		
Rotational frequency	Pulsation					
Angular acceleration	Accélération angulaire	α	$\alpha = \frac{d\omega}{dt}$	rad/s ²		
Speed	Vitesse	$u, v, w,$	$v = \frac{ds}{dt}$		1 km/h = 0.277778 m/s	
Velocity	Célérité	c		m/s	1 m/min = 0.0166 m/s	
Acceleration	Accélération	a	$a = \frac{dv}{dt}$	m/s ²		
Acceleration due to gravity	Accélération de la pesanteur	$g = 9.81 \text{ m/s}^2$ approx				
Speed of rotation	Vitesse de rotation	N		s ⁻¹	min ⁻¹	tr/mn, RPM, TM...
Mass	Masse	m		kg (kilogramme)	tonne : t 1 t = 1000 kg	kilo, kgs, KG... 1 pound : 1 lb = 0.4536 kg
Density	Masse volumique	ρ	$\frac{dm}{dV}$	kg/m ³		
Linear density	Masse linéique	ρ_e	$\frac{dm}{dL}$	kg/m		
Surface density	Masse surfacique	ρ_A	$\frac{dm}{dS}$	kg/m ²		
Momentum	Quantité de mouvement	P	$p = m.v$	kg.m/s		
Moment of inertia	Moment d'inertie	J, I	$I = \sum m.r^2$	kg.m ²		$J = \frac{MD^2}{4}$ kg.m ² pound per square foot = 1 lb.ft ² = 42.1 x 10 ⁻³ kg.m ²
Force	Force	F		N (newton)		kgf = kgp = 9.81 N pound force = lbf = 4.448 N
Weight	Poids	G	$G = m.g$			
Moment of force, Torque	Moment d'une force	M T	$M = Fr$	N.m		mdaN, mkg, m.N 1 mkg = 9.81 N.m 1 ft.lbf = 1.356 N.m 1 in.lbf = 0.113 N.m
Pressure	Pression	p	$p = \frac{F}{S} = \frac{F}{A}$	Pa (pascal)	bar 1 bar = 10 ⁵ Pa	1 kgf/cm ² = 0.981 bar 1 psi = 6894 N/m ² = 6894 Pa 1 psi = 0.06894 bar 1 atm = 1.013 x 10 ⁵ Pa
Normal stress	Contrainte normale	σ		Pa		kg/mm ² , 1 daN/mm ² = 10 MPa
Shear stress	Contrainte tangentielle, Cission	τ		Pa Leroy-Somer use the MPa = 10 ⁶ Pa		psi = pound per square inch 1 psi = 6894 Pa
Friction factor	Facteur de frottement	μ				incorrectly = friction coefficient f
Work	Travail	W	$W = F.l$			1 N.m = 1 W.s = 1 J
Energy	Energie	E			Wh = 3600 J (watt-hour)	1 kgm = 9.81 J
Potential energy	Energie potentielle	E_p		J (joule)		1 cal = 4.18 J (calorie)
Kinetic energy	Energie cinétique	E_k				1 Btu = 1055 J
Quantity of heat	Quantité de chaleur	Q				(British thermal unit)
Power	Puissance	P	$P = \frac{W}{t}$	W (watt)		1 ch = 736 W 1 HP = 746 W
Volumetric flow	Débit volumique	q_v	$q_v = \frac{dV}{dt}$	m ³ /s		
Efficiency	Rendement	η		< 1		%
Dynamic viscosity	Viscosité dynamique	η, μ		Pa.s		poise, 1 P = 0.1 Pa.s
Kinematic viscosity	Viscosité cinématique	ν	$\nu = \frac{\eta}{\rho}$	m ² /s		stokes, 1 St = 10 ⁻⁴ m ² /s

Single phase induction motors

General information

A5 - Unit conversions

Units	MKSA (IS International system)	AGMA (US system)
Length	1 m = 3.2808 ft 1 mm = 0.03937 in	1 ft = 0.3048 m 1 in = 25.4 mm
Mass	1 kg = 2.2046 lb	1 lb = 0.4536 kg
Torque	1 Nm = 0.7376 lb.ft 1 N.m = 141.6 oz.in	1 lb.ft = 1.356 N.m 1 oz.in = 0.00706 N.m
Force	1 N = 0.2248 lb	1 lb = 4.448 N
Moment of inertia	1 kg.m ² = 23.73 lb.ft ²	1 lb.ft ² = 0.04214 kg.m ²
Power	1 kW = 1.341 HP	1 HP = 0.746 kW
Pressure	1 kPa = 0.14505 psi	1 psi = 6.894 kPa
Magnetic flux	1 T = 1 Wb / m ² = 6.45210 ⁴ line / in ²	1 line / in ² = 1.55010 ⁻⁵ Wb / m ²
Magnetic losses	1 W / kg = 0.4536 W / lb	1 W / lb = 2.204 W / kg



Multiples and sub-multiples		
Multiplication factor	Unit name prefix	Symbol which should precede unit symbol
10 ¹⁸ or 1,000,000,000,000,000,000	exa	E
10 ¹⁵ or 1,000,000,000,000,000	peta	P
10 ¹² or 1,000,000,000,000	tera	T
10 ⁹ or 1,000,000,000	giga	G
10 ⁶ or 1,000,000	mega	M
10 ³ or 1,000	kilo	k
10 ² or 100	hecto	h
10 ¹ or 10	deca	da
10 ⁻¹ or 0.1	deci	d
10 ⁻² or 0.01	centi	c
10 ⁻³ or 0.001	milli	m
10 ⁻⁶ or 0.000,001	micro	μ
10 ⁻⁹ or 0.000,000,001	nano	n
10 ⁻¹² or 0.000,000,000,001	pico	p
10 ⁻¹⁵ or 0.000,000,000,000,001	femto	f
10 ⁻¹⁸ or 0.000,000,000,000,000,001	atto	a

Single phase induction motors

General information

A6 - Standard formulae used in electrical engineering

A6.1 - MECHANICAL FORMULAE

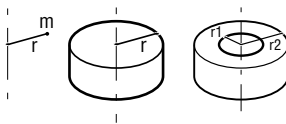
Title	Formula	Units	Definitions / notes
Force	$F = m \cdot \gamma$	F in N m in kg γ in m/s ²	A force F is the product of a mass m multiplied by an acceleration γ
Weight	$G = m \cdot g$	G in N m in kg $g = 9.81$ m/s ²	
Moment	$M = F \cdot r$	M in Nm F in N r in m	The moment M of a force in relation to an axis is the product of that force multiplied by the distance r of the point of application of F in relation to the axis.
Power	- Rotation $P = M \cdot \omega$ - Linear $P = F \cdot V$	P in W M in Nm ω in rad/s P in W F in N V in m/s	Power P is the quantity of work yielded per unit of time $\omega = 2\pi N/60$ where N is the speed of rotation in min ⁻¹ $V =$ linear velocity
Acceleration time	$t = J \cdot \frac{\omega}{M_a}$	t in s J in m ² kg ω in rad/s M_a in Nm	J is the moment of inertia of the system M_a is the moment of acceleration Note: All the calculations refer to a single rotational speed ω where the inertias at ω' are corrected to speed ω by the following calculation : $J_{\omega} = J_{\omega'} \cdot \left(\frac{\omega'}{\omega}\right)^2$
Moment of inertia Centre of gravity	$J = m \cdot r^2$	J in m ² kg m in kg r in m	
Solid cylinder	$J = m \cdot \frac{r^2}{2}$		
Hollow cylinder	$J = m \cdot \frac{r_1^2 + r_2^2}{2}$		
Inertia of a mass in linear motion	$J = m \cdot \left(\frac{V}{\omega}\right)^2$	J in m ² kg m in kg v in m/s ω in rad/s	The moment of inertia of a mass in linear motion transformed to a rotating motion.

Single phase induction motors

General information

A6.2 - ELECTRICAL FORMULAE



Title	Formula	Units	Definitions / notes
Accelerating torque	$M_a = \frac{M_D + 2 M_A + 2 M_M + M_N}{6} - M_r$ <p>General formula :</p> $M_a = \frac{1}{N_N} \int_0^{N_N} (M_{mot} - M_r) dN$	Nm	Moment of acceleration M_a is the difference between the motor torque (estimated) and the resistive torque of the load M_r (For M_D, M_A, M_M, M_N see curve below) N = instantaneous speed N_N = rated speed
Power required by machine	$P = \frac{M \cdot \omega}{\eta_A}$	P in W M in Nm ω in rad/s η_A no unit	η_A expresses the efficiency of the driven machine. M is the torque required by the driven machine.
Power drawn by the three-phase motor	$P = U \cdot I \cdot \cos \varphi$	P in W U in V I in A	φ phase angle by which the current lags or leads the voltage. U/phase to phase voltage. I/line current.
Reactive power absorbed by the motor	$Q = U \cdot I \cdot \sin \varphi$	Q in VAR	
Apparent power	$S = U \cdot I$ $S = \sqrt{P^2 + Q^2}$	S in VA	
Power supplied by three-phase motor	$P = U \cdot I \cdot \cos \varphi \cdot \eta$		η expresses motor efficiency at the point of operation under consideration.
Slip	$g = \frac{N_s - N}{N_s}$		Slip is the difference between the actual motor speed N and the synchronous speed N_s
Synchronous speed	$N_s = \frac{120 \cdot f}{p}$	N_s in min^{-1} f in Hz	p = number of poles. f = frequency of the power supply

Variable	Symbol	Unit	Torque and current vs speed
Starting current	I_D	A	
Rated current	I_N		
No-load current	I_O		
Starting torque	M_D	Nm	
Run up torque	M_A		
Breakdown torque	M_M		
Rated torque	M_N		
Rated speed	N_N	min^{-1}	
Synchronous speed	N_S		

Single phase induction motors Environment

B1 - Definition of "Index of Protection" (IP/IK)

Indices of protection of electrical equipment enclosures
Conforming to standards IEC 34-5 - EN 60034-5 (IP) - EN 50102 (IK)

LS motors are IP 55 / IK 07
as standard

First number : protection against solid objects			Second number : protection against liquids			mechanical protection		
IP	Tests	Definition	IP	Tests	Definition	IK	Tests	Definition
0		No protection	0		No protection	00		No protection
1	 Ø 50 mm	Protected against solid objects of over 50 mm (eg : accidental hand contact)	1	 ↓	Protected against vertically dripping water (condensation)	01	 150 g 10 cm	Impact energy : 0.15 J
2	 Ø 12 mm	Protected against solid objects of over 12 mm (eg : finger)	2	 15°	Protected against water dripping up to 15° from the vertical	02	 200 g 10 cm	Impact energy : 0.20 J
3	 Ø 2.5 mm	Protected against solid objects of over 2.5 mm (eg : tools, wire)	3	 60°	Protected against rain falling at up to 60° from the vertical	03	 250 g 15 cm	Impact energy : 0.37 J
4	 Ø 1 mm	Protected against solid objects of over 1 mm (eg : small tools, thin wire)	4	 ↓	Protected against water splashes from all directions	04	 250 g 20 cm	Impact energy : 0.50 J
5	 ↓	Protected against dust (no deposits of harmful material)	5	 ↓	Protected against jets of water from all directions	05	 350 g 20 cm	Impact energy : 0.70 J
			6	 ↓	Protected against jets of water comparable to heavy seas	06	 250 g 40 cm	Impact energy : 1 J
			7	 0.15 m	Protected against the effects of immersion to depths of between 0.15 and 1 m	07	 0.5 kg 40 cm	Impact energy : 2 J
			8	 1 m	Protected against the effects of prolonged immersion under pressure	08	 1.25 kg 40 cm	Impact energy : 5 J
						09	 2.5 kg 40 cm	Impact energy : 10 J
						10	 5 kg 40 cm	Impact energy : 20 J

Example :

IP 55 machine

IP : Index of protection

- 5** : Machine protected against dust and accidental contact
Test result : no dust enters in harmful quantities; no risk of direct contact with rotating parts. The test lasts 2 hours (test result : no talc enters which might adversely affect the machine operation).
- 5** : Machine protected against jets of water from all directions from hoses at 3m distance with a flow rate of 12.5 l/min at 0.3 bar.
The test lasts 3 minutes (test result: no damage from water projected on to the machine).

Single phase induction motors Environment

B2 - Environmental limitations

B2.1 - NORMAL OPERATING CONDITIONS

a / Under IEC 34-1, motors must be able to operate under the following normal conditions :

- ambient temperature of between - 16° C and + 40° C
- altitudes of under 1000 m.
- atmospheric pressure : 1050 hPa (mbar) = (750 mm Hg)

b / Power correction factor :

For operating conditions outside these limits, apply the power correction coefficient shown in the chart on the right *which maintains the thermal reserve*, as a function of the altitude and ambient temperature.

The output power can only be corrected upwards once the ability of the motor to start the load has been checked.

▼ *Correction coefficient table*

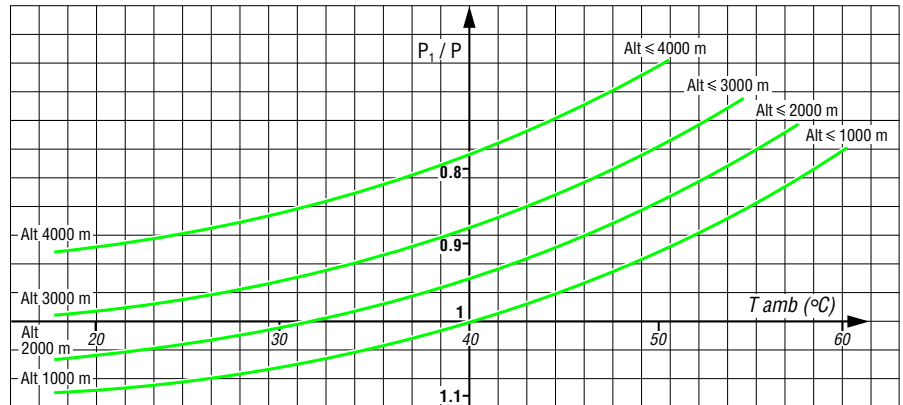

B2.2 - NORMAL STORAGE CONDITIONS

Machines should be stored at an ambient temperature between - 16° and + 40° C and a relative humidity of less than 90%. For restarting, see commissioning manual.

B2.3 - RELATIVE AND ABSOLUTE HUMIDITY

Measuring the humidity :

Humidity is usually measured by the "wet and dry bulb thermometer" method.

Absolute humidity, calculated from the readings taken on the two thermometers, can be determined using the chart on the right. The chart also provides relative humidity figures.

To determine the humidity correctly, a good air flow is required for stable readings, and accurate readings must be taken on the thermometers.

During the construction of aluminium motors, the materials of the various components which are in contact with one another are selected so as to minimise deterioration by galvanic effect. The voltages in the metal combinations used, (cast iron-steel ; cast iron-aluminium ; steel-aluminium ; steel-tin) are too low to cause deterioration.

In temperate climates, relative humidity is generally between 50 and 70 %. For the relationship between relative humidity and motor impregnation, especially where humidity and temperature are high, see table on next page.

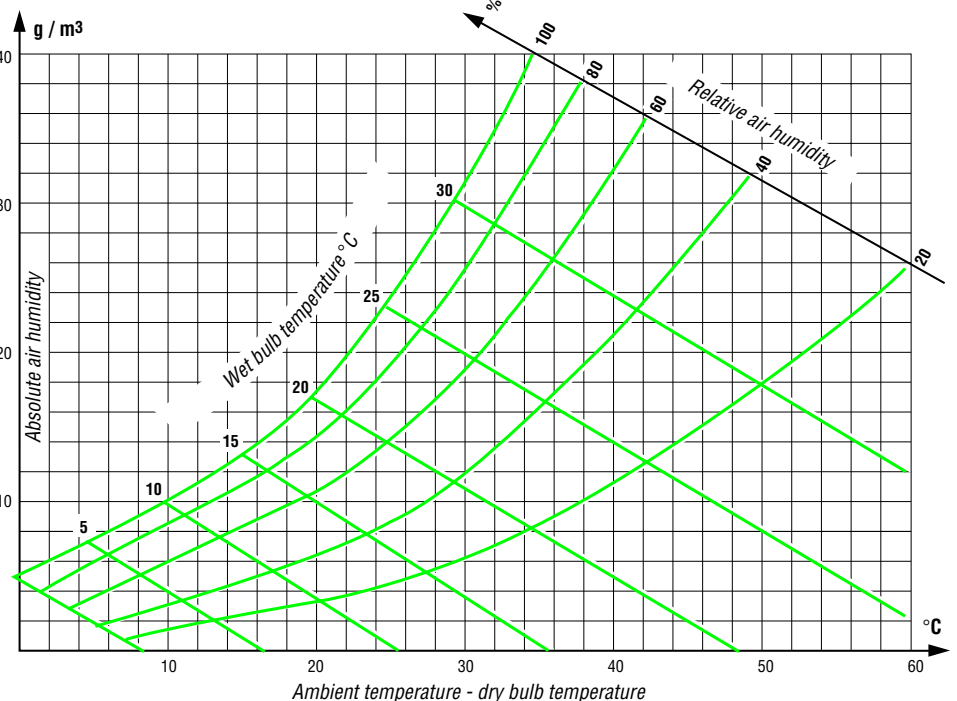

B2.4 - DRAIN HOLES

Holes are provided at the lowest points of the enclosure to drain off any moisture that may have accumulated inside during cooling of the machine.

The holes may be sealed in various ways :

- standard : with plastic plugs,
- on request : with screws, syphon or plastic ventilator.

Under certain special conditions, it is advisable to leave the drain holes permanently open (operating in environment with high levels of condensation).

Opening the holes periodically should be part of the regular maintenance procedure.

B2.5 - DRIP COVER

For machines operating outdoors, with the drive shaft downwards, drip covers are recommended. This is an option and should be specified on the order if required.

The dimensions are given in the dimensions tables.

Single phase induction motors Environment

B3 - Impregnation and enhanced protection

LS motors are T configuration as standard

B



B3.1 - NORMAL ATMOSPHERIC PRESSURE (750 mm Hg)

The selection table below can be used to find the method of manufacture best suited to particular environments in which temperature and relative humidity show large degrees of variation (see relative and absolute humidity calculation method on preceding page).

The symbols used refer to permutations of components, materials, impregnation methods and finishes (varnish or paint).

The protection of the winding is generally described by the term "tropicalization".

For high humidity environments, we advise that the windings are preheated (see section B4.1).

Relative humidity	Frame size 56 to 132			Influence on manufacture
	RH < 90 %	RH 90 to 98 %*	RH > 98 %*	
Ambient temperature				 <p>Increased derating</p>
- 16 to + 40 °C	T Standard or T0	TR Standard or TR0	TC Standard or TC0	
- 16 to + 65 °C	T2	TR2	TC2	
Plate mark	T	TR	TC	
Influence on manufacturing	 <p>Increased protection of windings</p>			

* atmosphere without high levels of condensation

 Standard impregnation

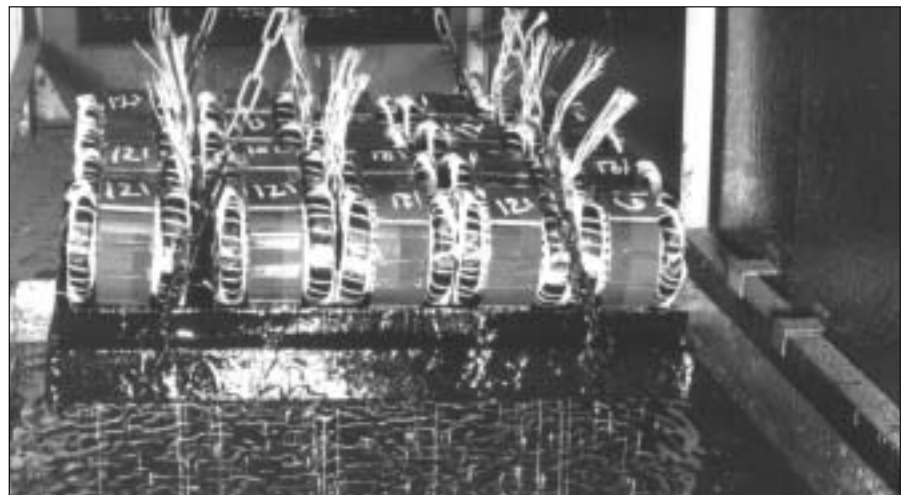

Single phase induction motors Environment

B3.2 - INFLUENCE OF ATMOSPHERIC PRESSURE

As atmospheric pressure decreases, air particles rarefy and the environment becomes increasingly conductive.

The curve below shows the increase in isolation distance required, according to atmospheric pressure.

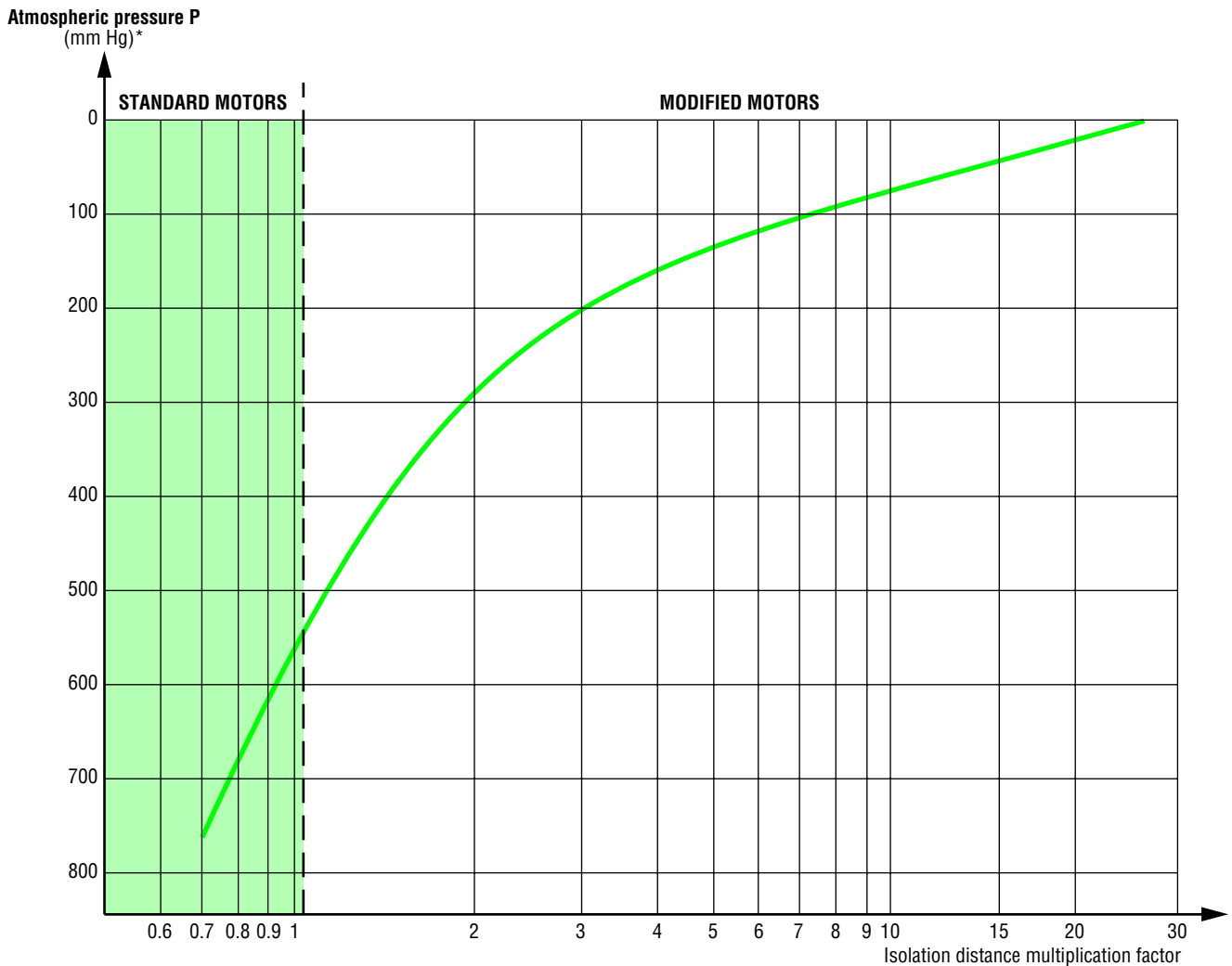

* 1 mm Hg = 1.333 mbar = 1.333×10^2 Pa

Solutions for permanent applications : offers based on specification

- P > 550 mm Hg : Standard impregnation according to previous table - Possible derating or forced ventilation.
- P > 200 mm Hg : Coating of bearings - Flying leads up to a zone at P ~ 750 mm Hg - Derating to take account of insufficient ventilation - Forced ventilation.
- P < 200 mm Hg : Special manufacture based on specification.

In all cases, these problems should be resolved by a special contract worked out on the basis of a specification.

Single phase induction motors Environment

B4 - Heaters

B4.1 - SPACE HEATERS

Severe climatic conditions, e.g. below - 40° C, RH >95%, etc, may require the use of space heaters (fitted to the motor windings) which serve to maintain the average temperature of the motor, provide trouble-free starting and eliminate problems caused by condensation (loss of insulation).

The heater supply wires are brought out to a terminal block in the motor terminal box. The heaters must be switched off while the machine is in operation.

Motor type	No. of poles	Power : P(W)
LS 100 to LS 132	2 - 4	25

The space heaters use 200/240V, single phase, 50 or 60 Hz.

B

Single phase induction motors Environment

B5 - External finish

LS motors
conform to System Ia

LEROY-SOMER motors are protected with a range of surface finishes. The surfaces receive appropriate special treatments, as shown below.

Preparation of surfaces

SURFACE	PARTS	TREATMENT
Cast iron	End shields	Shot blasting + primer
Steel	Accessories	Phosphatization + primer
	Terminal box & fan cover	Electrostatic painting or Epoxy powder
Aluminium alloy	Housing - Terminal box	Shot blasting
Plastic	Fan covers - Terminal box	None, but must be free from grease, casting-mould coatings, and dust which would affect paint adhesion.

B

Definition of atmospheres

An atmosphere is said to be CORROSIVE when components are attacked by oxygen. It is said to be HARSH when components are attacked by bases, acids or salts.

Painting systems

PRODUCTS	ATMOSPHERE	SYSTEM	APPLICATIONS	RESISTANCE TO SALINE MIST standard NFX 41002
standard frame 56 to 90 mm	Clean, dry	I	1 coat nitrosynthetic finish 15/20 µm	70 hours
standard frame 110 to 132 mm	Clean, dry (indoors, rural or industrial)	Ia	1 coat polyurethane finish 25/30µ	72 hours
option	Moderately corrosive : humid, outdoors (temperate climate).	IIa	1 base coat epoxy 35/40 µm 1 coat polyurethane finish 25/30 µm	150 hours
option	Corrosive : coastal, very humid (tropical climate).	IIIa	1 base coat epoxy before assembly on internal and external surfaces of cast iron parts 35/40 µm 1 intermediate coat epoxy 35/40 µm 1 coat polyurethane finish 25/30 µm	300 hours
option	Painting system for water and environments not in contact with chlorinated or sulphurous products.	IIIe	1 base coat epoxy 50/60 µm 1 intermediate coat epoxy 50/60 µm 1 coat epoxy finish 35/40 µm	500 hours

Systems I and Ia are for moderate climates and System IIa is for general climates as defined in standard NFC 20 000 (or IEC 721.2.1). Exposure to saline mist under the terms of standard NFX 41002 (5% NaCl at 6 < pH < 7.5 at 35° and 1 bar).

LEROY-SOMER standard paint colour reference :

RAL 6000

Single phase induction motors Construction

C1 - Components

Description of standard LS 3-phase motors

Component	Materials	Remarks
1 Finned housing	Aluminium alloy	- with integral feet, detachable feet or without feet - pressure die-cast for frame sizes \leq 132 <ul style="list-style-type: none"> • 4 or 6 screw holes for foot mounting • eye bolts, optional on 132 and 112 - optional earth terminal
2 Stator	Insulated low-carbon magnetic steel laminations. Cathode copper	- low carbon content guarantees long-term lamination pack stability - welded packs - semi-enclosed slots - class F insulation
3 Rotor	Insulated low-carbon magnetic steel laminations. Aluminium or aluminium alloy	- inclined cage bars - rotor cage pressure die-cast in aluminium (or alloy for special applications) - shrink-fitted to shaft - dynamically balanced rotor (1/2 key)
4 Shaft	Steel	- for frame size < 132 : <ul style="list-style-type: none"> • shaft end fitted with screw and washer • closed keyway
5 End shields	Aluminium alloy	- LS 56 to 90
	Cast iron	- LS 71 - LS 80 - 90 drive end (drive end and non-drive end optional) - LS 100 to 132 drive end and non-drive end
6 Bearings and lubrication		- ball bearings - 'greased for life' up to 132 frame inclusive - non-drive end bearings preloaded
7 Labyrinth seals Lipseals	Plastic or steel Synthetic rubber	- DE lipseal or deflector for all flange and face-mounted motors - lipseal, deflector or labyrinth for foot-mounted motors
8 Fan	Composite material or aluminium alloy	- 2 directions of rotation : straight blades
9 Fan cover	Composite material or pressed steel	- on request, fitted with a drip cover for operation in vertical position, shaft facing down.
10 Terminal box	Aluminium alloy	- IP 55 - on opposite side to feet. - contains a terminal block with steel terminals as standard - terminal box comes complete with cable gland (optionally without cable gland) - 1 earth terminal in each terminal box
11 Permanent capacitor		- outside terminal box (optionally on inside)
12 Starting capacitor		- inside terminal box
13 Voltage relay		- dual-frequency 50/60 Hz

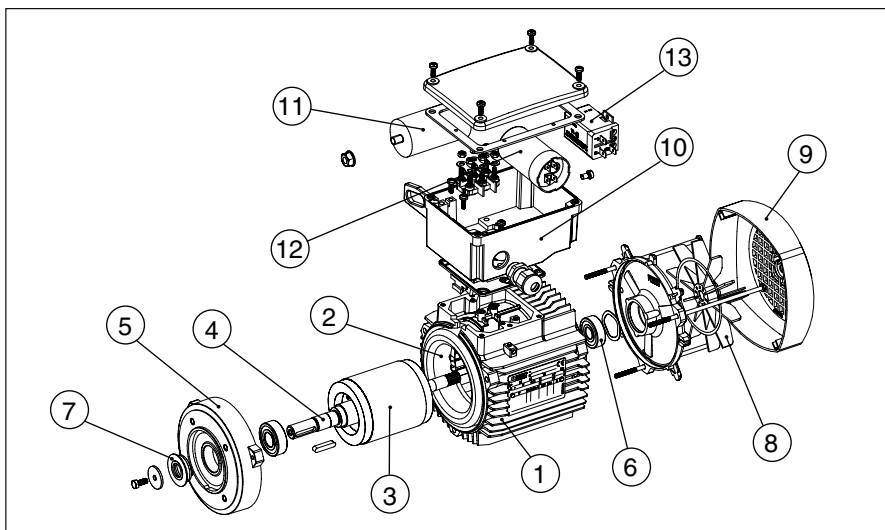

Single phase induction motors Construction

C2 - Mounting arrangements

C2.1 - MOUNTING ARRANGEMENTS



The various mounting arrangements for machines are defined in IEC 34-7. Below is an extract from the standard which shows equivalent terms in current use.

Code formulation

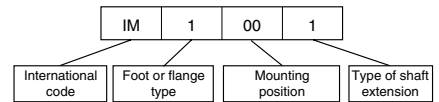

Code I	Code II
IM B 3	IM 1001
IM V 5	IM 1011
IM V 6	IM 1031
IM B 6	IM 1051
IM B 7	IM 1061
IM B 8	IM 1071
IM B 20	IM 1101
IM B 15	IM 1201
IM B 35	IM 2001
IM V 15	IM 2011
IM V 36	IM 2031
IM B 34	IM 2101
IM B 5	IM 3001
IM V 1	IM 3011
IM V 21	IM 3051
IM V 3	IM 3031
IM V 4	IM 3211
IM V 2	IM 3231
IM B 14	IM 3601
IM V 18	IM 3611
IM V 19	IM 3631
IM B 10	IM 4001
IM V 10	IM 4011
IM V 14	IM 4031
IM V 16	IM 4131
IM B 9	IM 9101
IM V 8	IM 9111
IM V 9	IM 9131
IM B 30	IM 9201
IM V 30	IM 9211
IM V 31	IM 9231

Codes I and II are interchangeable. It should however be noted that the above code list is not exhaustive and you should therefore refer to IEC 34-7 for other designations. On the next page you will find the most common mounting arrangements, with line drawings and an explanation of the standard symbols used.

Possible mounting positions depending on the frame size

Certain operating positions are not possible for a production motor. Select the possible configurations for machine installation in the table below. In the event of any problems, please consult Leroy-Somer.

Frame size	Mounting position											
	IM 1001	IM 1051	IM 1061	IM 1071	IM 1011	IM 1031	IM 3001	IM 3011	IM 3031	IM 2001	IM 2011	IM 2031
56 to 132	●	●	●	●	●	●	●	●	●	●	●	●

● : possible positions.

Single phase induction motors Construction

C2.2 - MOUNTINGS AND POSITIONS (EN 60034-7 standard)

Foot mounted motors

IM 1001 (IM B3)
- Horizontal shaft
- Feet on floor

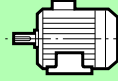

IM 1071 (IM B8)
- Horizontal shaft
- Feet on ceiling

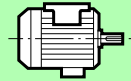

IM 1061 (IM B7)
- Horizontal shaft
- Wall mounted with feet on left hand side when viewed from drive end

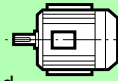

IM 1011 (IM V5)
- Vertical shaft facing down
- Feet on wall

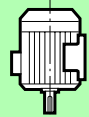

IM 1061 (IM B7)
- Horizontal shaft
- Wall mounted with feet on right hand side when viewed from drive end

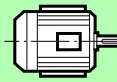

IM 1031 (IM V6)
- Vertical shaft facing up
- Feet on wall

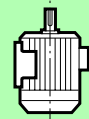

(FF) flange mounted motors

IM 3001 (IM B5)
- Horizontal shaft

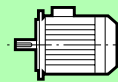

IM 2001 (IM B35)
- Horizontal shaft
- Feet on floor

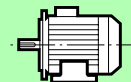

IM 3011 (IM V1)
- Vertical shaft facing down

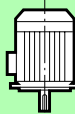

IM 2011 (IM V15)
- Vertical shaft facing down
- Feet on wall

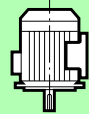

IM 3031 (IM V3)
- Vertical shaft facing up



IM 2031 (IM V36)
- Vertical shaft facing up
- Feet on wall

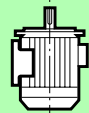

(FT) face mounted motors

IM 3601 (IM B14)
- Horizontal shaft

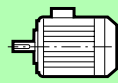

IM 2101 (IM B34)
- Horizontal shaft
- Feet on floor

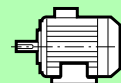

IM 3611 (IM V18)
- Vertical shaft facing down



IM 2111 (IM V58)
- Vertical shaft facing down
- Feet on wall

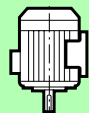

IM 3631 (IM V19)
- Vertical shaft facing up



IM 2131 (IM V69)
- Vertical shaft facing up
- Feet on wall

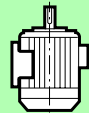

Motors without drive end shield

Important : the protection (IP) specified on the IM B9 and IM B15 motor plates is provided by the customer when the motor is assembled.

IM 9101 (IM B9)
- Threaded tie rods
- Horizontal shaft

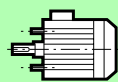

IM 1201 (IM B15)
- Feet and threaded tie rods
- Horizontal shaft

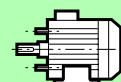

Single phase induction motors Construction

C3 - Bearings and lubrication

C3.1 - BEARINGS AND BEARING LIFE

Definitions

Load ratings

- Basic static load C_0 :

This is the load for which permanent deformation at point of contact between a bearing race and the ball (or roller) with the heaviest load reaches 0.01% of the diameter of the ball or (roller).

- Basic dynamic load C :

This is the load (constant in intensity and direction) for which the nominal lifetime of the bearing will reach one million revolutions.

The static load rating C_0 and the dynamic load rating C are obtained for each bearing by following the method in ISO 281.

Lifetime

The lifetime of a bearing is the number of revolutions (or number of operating hours at a constant speed) that the bearing can accomplish before the first signs of fatigue (spalling) begin to appear on a ring or rolling component.

- Nominal lifetime L_{10h}

According to the ISO recommendations, the nominal lifetime is the length of time completed or exceeded by 90% of apparently identical bearings operating under the conditions specified by the manufacturer.

Note : The majority of bearings last much longer than the nominal lifetime; the average length of time achieved or exceeded by 50% of bearings is around 5 times longer than the nominal lifetime.

Determination of nominal lifetime

Constant load and rotation speed

The nominal lifetime of a bearing expressed in operating hours L_{10h} , the dynamic load C expressed in daN and the load applied (radial load F_r and axial load F_a) are related by the following equation :

$$L_{10h} = \frac{1000\ 000}{60 \cdot N} \cdot \left(\frac{C}{P}\right)^p$$

where N = rotational speed (min^{-1})

P ($P = X F_r + Y F_a$) : Equivalent Dynamic Load (F_r , F_a , P in daN)

p : an index which depends on the type of contact between the races and the rolling elements

$p = 3$ for ball bearings

$p = 10/3$ for roller bearings

The formulae that give Equivalent Dynamic Load (values of factors X & Y) for different types of bearing may be obtained from the various bearing manufacturers.

Variable load and rotation speed

For bearings with periodically variable load and speed, the nominal lifetime is established using the equation :

$$L_{10h} = \frac{1000\ 000}{60 \cdot N_m} \cdot \left(\frac{C}{P_m}\right)^p$$

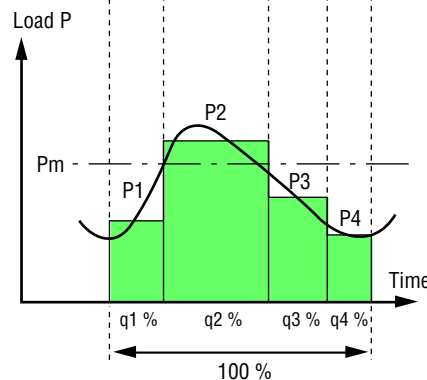
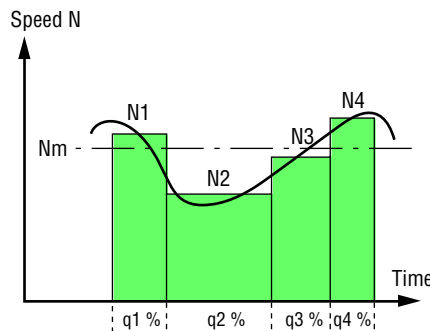

N_m : is the average rotational speed

$$N_m = N_1 \cdot \frac{q_1}{100} + N_2 \cdot \frac{q_2}{100} + \dots (\text{min}^{-1})$$

P_m : is the average equivalent dynamic load

$$P_m = \sqrt[p]{P_1^p \cdot \left(\frac{N_1}{N_m}\right)^p \cdot \frac{q_1}{100} + P_2^p \cdot \left(\frac{N_2}{N_m}\right)^p \cdot \frac{q_2}{100} + \dots (\text{daN})}$$

with q_1 , q_2 , etc. as percentages

Nominal lifetime L_{10h} is applicable to bearings made of bearing steel and normal operating conditions (lubricating film present, no pollution, correctly fitted, etc.).

Situations and data differing from those given above will lead to either a reduction or an increase in lifetime compared to the nominal lifetime.

Corrected nominal lifetime

If the ISO recommendations (DIN ISO 281) are used, improvements to bearing steel, manufacturing processes and the effects of operating conditions may be integrated into the nominal lifetime calculation.

The theoretical pre-fatigue lifetime L_{nah} is thus calculated using the formula :

$$L_{nah} = a_1 a_2 a_3 L_{10h}$$

with :

a_1 : as the failure probability factor.

a_2 : as the factor for the characteristics and tempering of the steel.

a_3 : as the factor for the operating conditions (lubricant quality, temperature, rotational speed, etc.).

Under normal operating conditions for LS motors, the corrected nominal lifetime, calculated with a failure probability factor $a_1 = 1$ (L_{10ah}), is longer than the nominal lifetime L_{10h} .



Single phase induction motors Construction

C3.2 - TYPES OF BEARING AND STANDARD FITTING ARRANGEMENTS

		Horizontal shaft		Vertical shaft	
				Shaft facing down	Shaft facing up
Foot-mounted motors	Mounting arrangement	B3 / B6 / B7 / B8		V5	
	standard mounting	The DE bearing is : - located at DE for frame ≤ 132		The DE bearing is : - located at DE for frame ≤ 132	
	on request	DE bearing locked		DE bearing locked	
Flange-mounted (or foot and flange) motors	Mounting arrangement	B5 / B35 / B14 / B34		V1 / V15 / V18 / V58	
	standard mounting	Locked at DE		Locked at DE	

Important : when ordering, state correct mounting type and position (see section C1)

Motor		No. of poles	Standard mountings			
Frame size	LEROY-SOMER designation		Non drive end bearing (N.D.E)	Drive end bearing (D.E)	Assembly diagram reference	
				Foot-mounted motors	Flange-mounted (or foot and flange) motors	
56	LS 56	2 ; 4	6201 2RS C3	6201 ZZ C3	1	3
63	LS 63	2 ; 4	6201 2RS C3	6202 ZZ C3	1	3
71	LS 71	2 ; 4 ; 6	6201 2RS C3	6202 2RS C3	1	2
80	LS 80	2 ; 4 ; 6	6203 2RS C3	6204 ZZ C3	4	7
90	LS 90	2 ; 4	6204 2RS C3	6205 ZZ C3	1	3
100	LS 100 L	2 ; 4	6205 ZZ C3	6206 ZZ C3	5	6
112	LS 112 MG	2 ; 4	6205 ZZ C3	6206 ZZ C3	5	6
132	LS 132 M-SM	2 ; 4	6207 ZZ C3	6308 ZZ C3	5	6

C3.2.1 - Bearing assembly diagrams

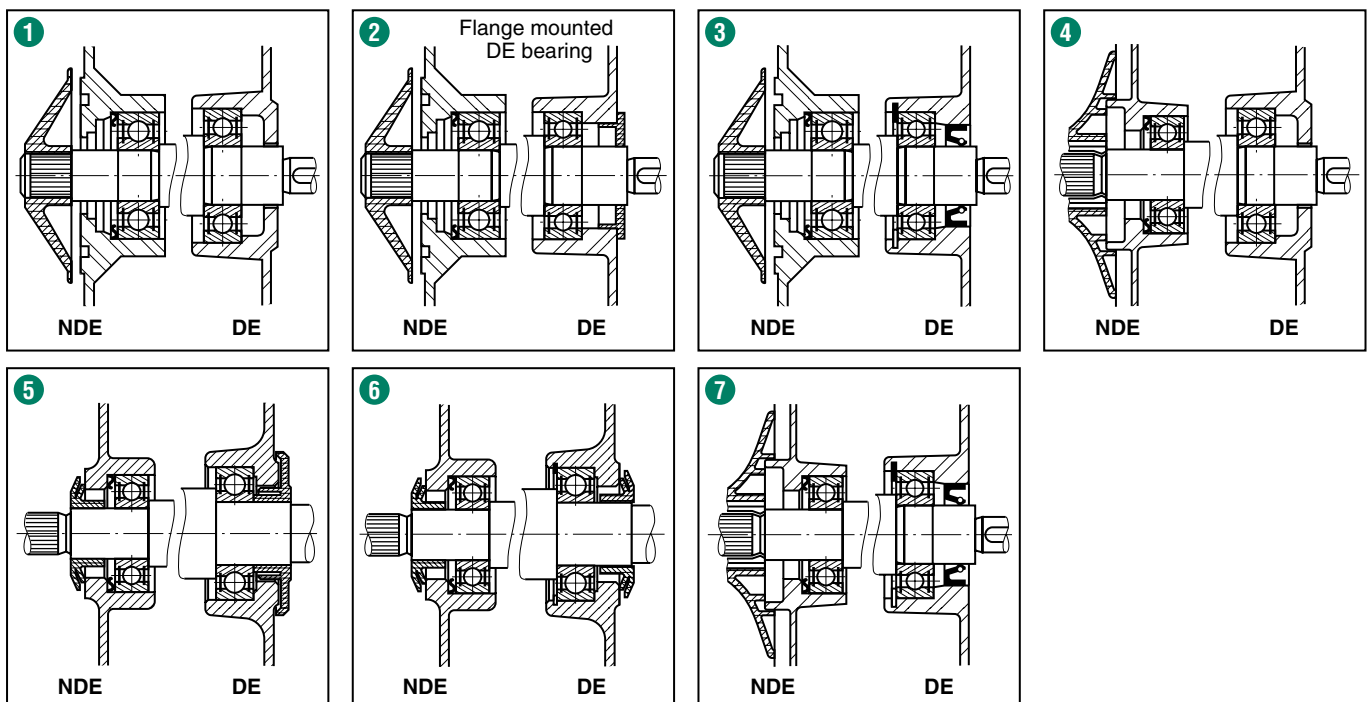

Single phase induction motors Construction

C3.2.2 - Permissible axial load (in daN) on main shaft extension for standard bearing assembly

Horizontal motor

Nominal bearing life L_{10h} :
25000 hours.

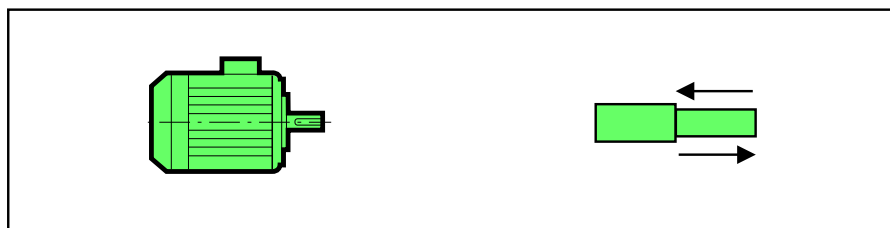

Motor		2 poles $N = 3000 \text{ min}^{-1}$		4 poles $N = 1500 \text{ min}^{-1}$		6 poles $N = 1000 \text{ min}^{-1}$	
Frame size	Type	→	←	→	←	→	←
		IM B3 / B6 IM B7 / B8 IM B5 / B35 IM B14 / B34	IM B3 / B6 IM B7 / B8 IM B5 / B35 IM B14 / B34	IM B3 / B6 IM B7 / B8 IM B5 / B35 IM B14 / B34	IM B3 / B6 IM B7 / B8 IM B5 / B35 IM B14 / B34	IM B3 / B6 IM B7 / B8 IM B5 / B35 IM B14 / B34	IM B3 / B6 IM B7 / B8 IM B5 / B35 IM B14 / B34
56	LS 56	7	(28)*	14	(35)*	-	-
63	LS 63	13	(34)*	18	(39)*	-	-
71	LS 71	13	(34)*	18	(39)*	26	(47)*
80	LS 80	23	(61)*	37	(75)*	45	(83)*
90	LS 90	19	(69)*	35	(85)*	-	-
100	LS 100 L	34	(90)*	57	(113)*		
112	LS 112 M-MG	32	(88)*	46	(102)*		
132	LS 132 SM-M	86	(188)*	125	(227)*		

* The axial loads shown above for IM B3/B6/B7/B8 with frame size ≤ 132 are the permissible axial loads for locked DE bearings (flange-mounted).

Single phase induction motors Construction

C3.2.2 - Permissible axial load (in daN) on main shaft extension for standard bearing assembly

Vertical motor
Shaft end down

Nominal bearing lifetime L_{10h} :
25000 hours.



Motor		2 poles $N = 3000 \text{ min}^{-1}$		4 poles $N = 1500 \text{ min}^{-1}$		6 poles $N = 1000 \text{ min}^{-1}$	
Frame size	Type	↓	↑	↓	↑	↓	↑
		IM V5 IM V1/V15 IM V18/V58..	IM V5 IM V1/V15 IM V18/V69..	IM V5 IM V1/V15 IM V18/V69..	IM V5 IM V1/V15 IM V18/V69..	IM V5 IM V1/V15 IM V18/V69..	IM V5 IM V1/V15 IM V18/V69..
56	LS 56	6	(24)*	13	(36)*	-	-
63	LS 63	11	(36)*	16	(41)*	-	-
71	LS 71	11	(36)*	16	(41)*	24	(49)*
80	LS 80	22	(63)*	35	(79)*	42	(89)*
90	LS 90	17	(73)*	31	(91)*	-	-
100	LS 100 L	32	(94)*	54	(119)*	-	-
112	LS 112 M-MG	29	(93)*	41	(111)*	-	-
132	LS 132 SM-M	73	(207)*	110	(251)*	-	-

* The axial loads shown above for IM V5 with frame size ≤ 132 are the permissible axial loads for locked DE bearings (flange-mounted).

Single phase induction motors Construction

C3.2.2 - Permissible axial load (in daN) on main shaft extension for standard bearing assembly

Vertical motor
Shaft facing upwards

Nominal bearing lifetime L_{10h} :
25000 hours..



Motor		2 poles $N = 3000 \text{ min}^{-1}$		4 poles $N = 1500 \text{ min}^{-1}$		6 poles $N = 1000 \text{ min}^{-1}$	
Frame size	Type	↓	↑	↓	↑	↓	↑
		IM V6 IM V3/V36 IM V19/V69	IM V6 IM V3/V36 IM V19/V69	IM V6 IM V3/V36 IM V19/V69	IM V6 IM V3/V36 IM V19/V69	IM V6 IM V3/V36 IM V19/V69	IM V6 IM V3/V36 IM V19/V69
56	LS 56	8	27	15	34	-	-
63	LS 63	15	32	20	37	-	-
71	LS 71	15	32	20	37	28	45
80	LS 80	60	25	73	41	80	51
90	LS 90	67	23	81	41	-	-
100	LS 100 L	88	38	110	63		
112	LS 112 M-MG	85	37	97	55		
132	LS 132 SM-M	175	105	212	149		



Single phase induction motors Construction

C3.2.3 - Permissible radial load on main shaft extension (length E)

In pulley and belt couplings, the shaft carrying the pulley is subjected to a radial force F_{pr} applied at a distance X (mm) from the shoulder of the shaft extension.

● Radial force applied to drive shaft extension : F_{pr}

The radial force F_{pr} expressed in daN applied to the shaft extension is found by the formula

$$F_{pr} = 1.91 \cdot 10^6 \frac{P_N \cdot k}{D \cdot N_N} \pm P_P$$

where :

P_N = rated motor power (kW)

D = external diameter of the drive pulley (mm)

N_N = rated speed of the motor (min^{-1})

k = factor depending on the type of transmission

P_P = weight of the pulley (daN)

The weight of the pulley is positive when it acts in the same direction as the tension force in the belt, and negative when it acts in the opposite direction.

Range of values for factor $k^{(*)}$

- toothed belts $k = 1$ to 1.5

- V-belts $k = 2$ to 2.5

- flat belts

• with tensioner $k = 2.5$ to 3

• without tensioner $k = 3$ to 4

(*) A more accurate figure for factor k can be obtained from the transmission suppliers.

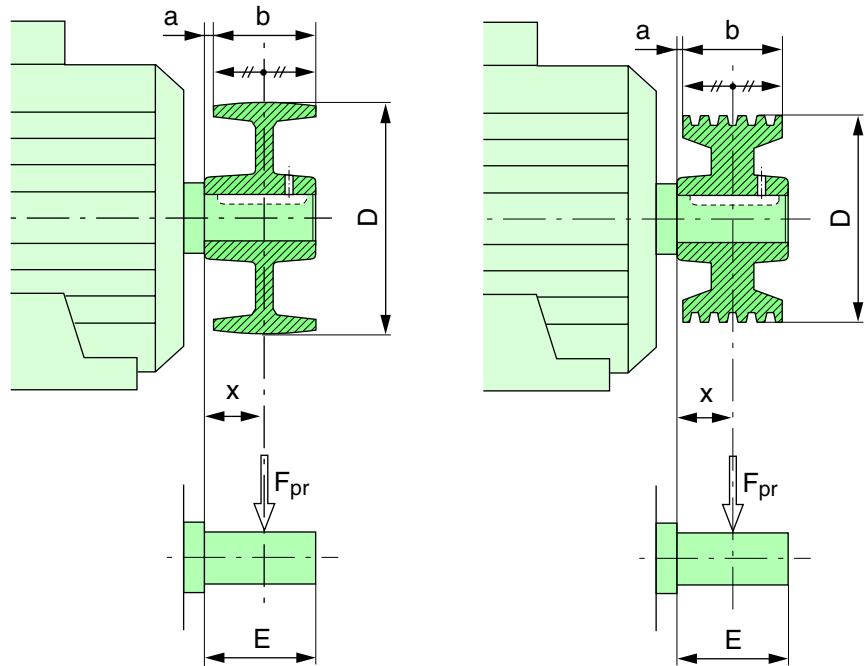

$$\left\{ \begin{array}{l} x = a + \frac{b}{2} \\ \text{where} \\ x \leq E \end{array} \right.$$

$$\left\{ \begin{array}{l} x = a + \frac{b}{2} \\ \text{where} \\ x \leq E \end{array} \right.$$

● Permissible radial load on the drive shaft extension

The charts on the following pages indicate for each type of motor the radial force F_R , at a distance X , permissible on the drive end shaft extension for a bearing life L_{10h} of 25000 hours.

Note : For frame sizes ≥ 315 M, the selection charts are applicable for a motor installed with the shaft horizontal.

● Changes in bearing life depending on the radial load factor

For a radial load F_{pr} ($F_{pr} \neq F_R$), applied at distance X , the bearing life L_{10h} changes, at a first approximation, in the ratio k_R , ($k_R = F_{pr} / F_R$) as shown in the chart opposite, for standard assemblies.

If the load factor k_R is greater than 1.05, you should consult our technical department, stating mounting position and direction of force before opting for a special assembly.

▼ Change in bearing life L_{10h} according to the radial load factor k_R for standard assemblies.

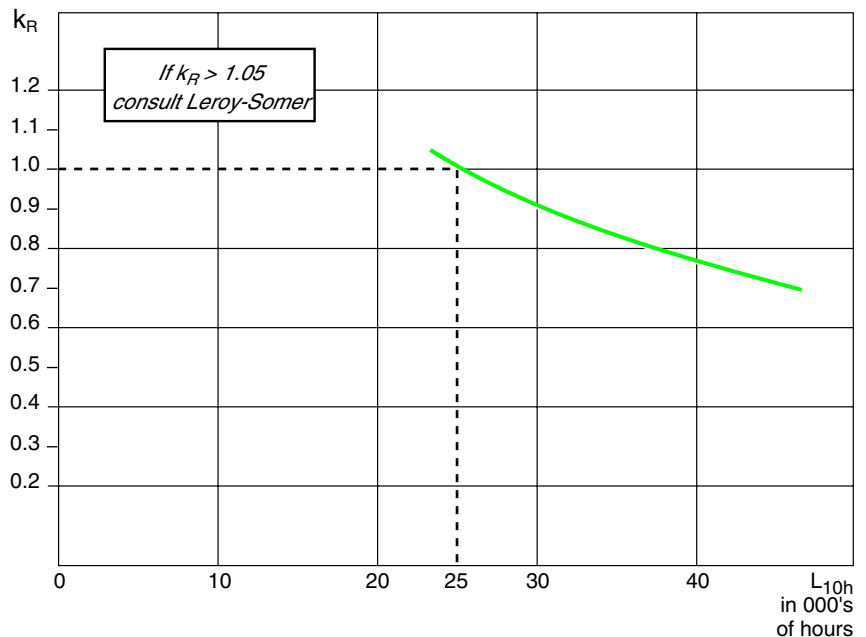

Single phase induction motors Construction

C3.2.3 - Standard assembly

Permissible radial load on main shaft extension with a bearing life L_{10h} of 25000 hours.

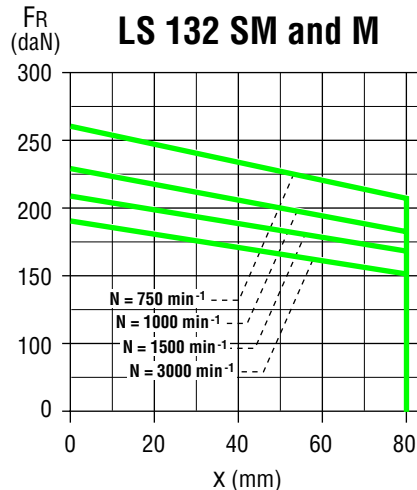
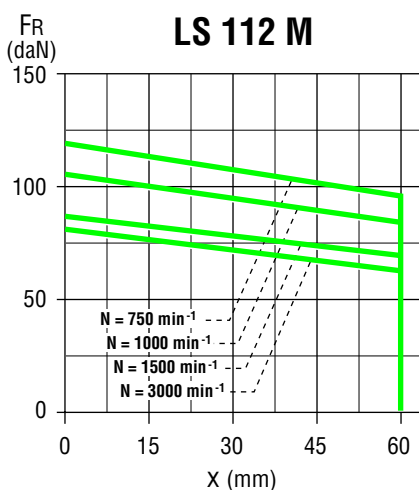
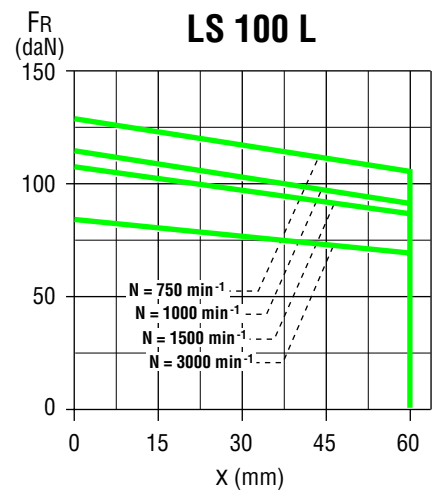
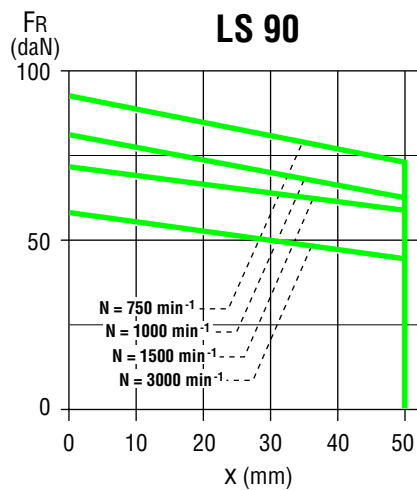
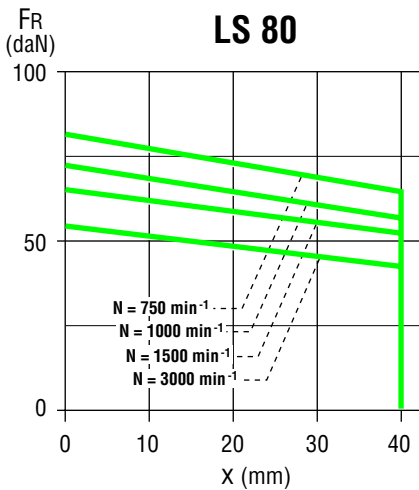
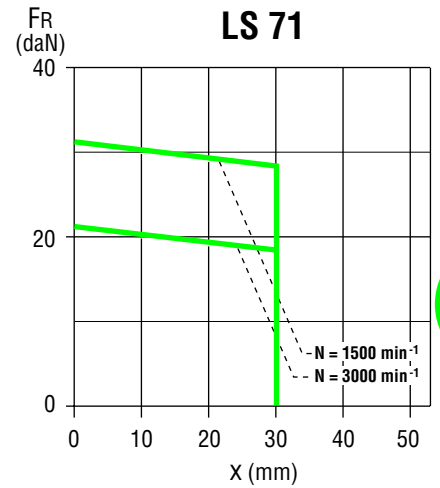
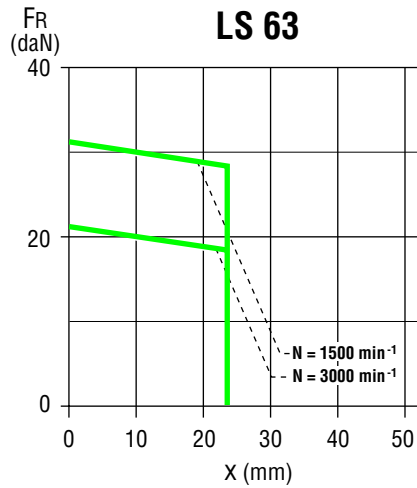
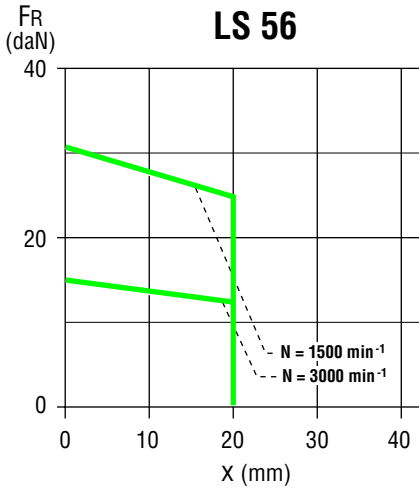

Single phase induction motors Construction

C3.3 - LUBRICATION AND MAINTENANCE OF BEARINGS

Grease life

The lifetime of a lubricating grease depends on :

- the characteristics of the grease (type of soap and base oil, etc.)
- service stress (type and size of bearing, speed of rotation, operating temperature, etc.)
- contamination

Permanently greased bearings

The type and size of the bearings make for long grease life and therefore lubrication for the lifetime of the machine. The grease life L_{10h} according to speed of rotation and ambient temperature is shown on the chart opposite.

▼ Grease life L_{10h} in 000's of hours

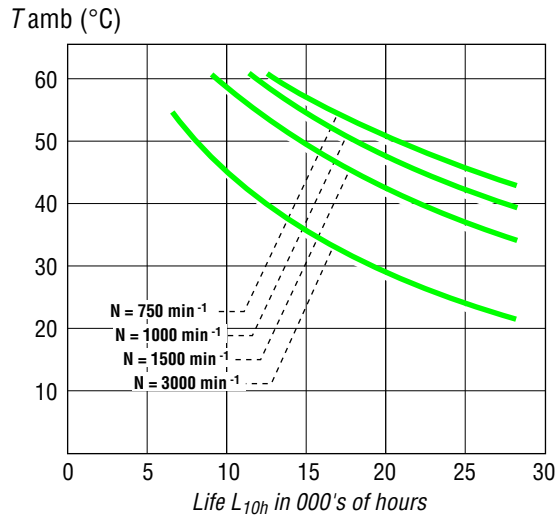

Single phase induction motors Construction

C4 - Cooling

LS motors are of standard configuration IC 411

New designation for the IC coded (International Cooling) cooling method in the EN 60034-6 standard.

The standard allows for two designations (general formula and simplified formula) as shown in the example opposite.

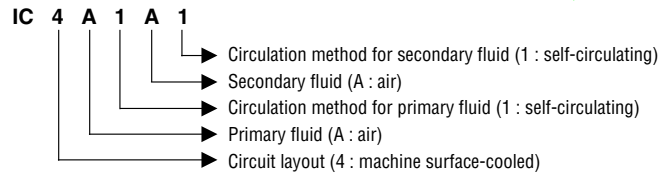

Note : the letter A may be omitted if this will not lead to confusion. This contracted formula becomes the simplified formula.
Simplified form : **IC 411**

Circuit layout			Coolant	
Characteristic number	Designation	Description	Characteristic letter	Type of fluid
0 (1)	Free circulation	The coolant enters and leaves the machine <i>freely</i> . It is taken from and returned to the fluid round the machine.	A	Air
1 (1)	Machine with an intake pipe	The coolant is taken up elsewhere than from the fluid round the machine, brought into the machine through an <i>intake pipe</i> and emptied into the fluid round the machine.	F	Freon
2 (1)	Machine with an outlet pipe	The coolant is taken up from the fluid round the machine, brought away from the machine by an <i>outlet pipe</i> and does not go back into the fluid round the machine.	H	Hydrogen
3 (1)	Machine with two pipes (intake and outlet)	The coolant is taken up elsewhere than from the fluid round the machine, brought to the machine through an <i>intake pipe</i> , then taken away from the machine through an <i>outlet pipe</i> and does not go back into the fluid round the machine.	N	Nitrogen
4	Surface cooled machine using the fluid round the machine	The primary coolant circulates in a closed circuit, transferring its heat to a secondary coolant (the one surrounding the machine) through the machine casing. The casing surface is either smooth or finned to improve heat transmission.	C	Carbon dioxide
5 (2)	Built-in heat exchanger (using the surrounding environment)	The primary coolant circulates in a <i>closed</i> circuit, transferring its heat to a secondary coolant (the one surrounding the machine) in an integral heat exchanger inside the machine.	W	Water
6 (2)	Machine-mounted heat exchanger (using the surrounding environment)	The primary coolant circulates in a closed circuit, transferring its heat to a secondary coolant (the one surrounding the machine) in a heat exchanger that forms an independent unit, mounted on the machine.	U	Oil
7 (2)	Built-in heat exchanger (not using the surrounding environment)	The primary coolant circulates in a closed circuit, transferring its heat to a secondary coolant (which is not the one round the machine) in an integral heat exchanger inside the machine.	S	Any other fluid (must be identified separately)
8 (2)	Machine-mounted heat exchanger (not using the surrounding environment)	The primary coolant circulates in a closed circuit, transferring its heat to a secondary coolant (which is not the one round the machine) in a heat exchanger that forms an independent unit, mounted on the machine.	Y	The fluid has not yet been selected (used temporarily)
9 (2) (3)	Separate heat exchanger (using/not using the surrounding environment)	The primary coolant circulates in a closed circuit, transferring its heat to the secondary fluid in a heat exchanger that forms an independent unit, away from the machine.		

Method of circulation		
Characteristic number	Designation	Description
0	Free convection	The circulation of the coolant is due only to differences in temperature. Ventilation caused by the rotor is negligible.
1	Self-circulating	The circulation of the coolant depends on the rotational speed of the main machine, and is caused either by the action of the rotor alone, or a device mounted directly on it.
2, 3, 4		Not yet defined.
5 (4)	Built-in, independent device	The coolant is circulated by a built-in device which is powered independently from the rotational speed of the main machine.
6 (4)	Machine-mounted independent device	The coolant is circulated by a device mounted on the machine which is powered independently from the rotational speed of the main machine.
7 (4)	Entirely separate independent device or using the pressure of the coolant circulation system	The coolant is circulated by a separate electrical or mechanical device, independent and not mounted on the machine, or by the pressure in the coolant circulation system.
8 (4)	Relative displacement	The circulation of the coolant is produced by the relative movement between the machine and the coolant, either by displacement of the machine in relation to the coolant, or by the flow of the surrounding coolant.
9	Any other device	The coolant is circulated using a method other than those defined above : it must be described in full.

(1) Filters or labyrinths for dust removal or noise protection can be fitted inside the casing or in the ducting. The first designation numbers 0 to 3 also apply to machines in which the coolant is taken up at the outlet of a watercooler designed to lower the temperature of the ambient air or recirculated through a watercooler so as not to increase the ambient temperature.

(2) The nature of the heat exchanger elements is not specified (smooth or finned tubes, corrugated surfaces, etc.).

(3) A separate heat exchanger can be installed near to or at a distance from the machine. A secondary gas coolant may or may not be the surrounding medium.

(4) Use of such a device does not exclude the ventilating action of the rotor or the existence of an additional fan mounted directly on the rotor.

Single phase induction motors Construction

C4.1 - STANDARD CODES

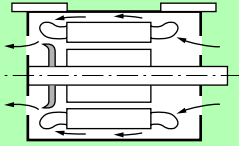
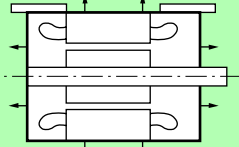
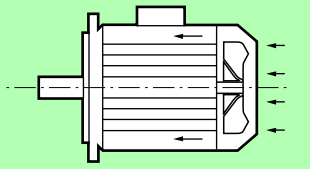
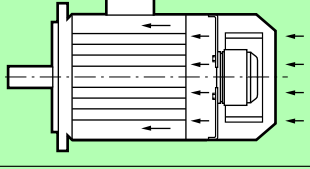
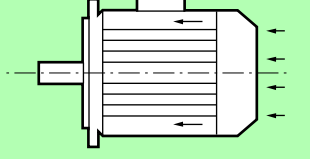
IC 01	Self-cooling open machine. Fan mounted on the shaft.	
IC 410	Enclosed machine, surface-cooled by natural convection and radiation. No external fan.	
IC 411	Enclosed machine. Smooth or finned ventilated casing. External shaft-mounted fan.	
IC 416	Enclosed machine. Smooth or finned enclosed casing. External motorized axial (A) fan supplied with machine.	
IC 418	Enclosed machine. Smooth or finned casing. No external fan. Ventilation provided by air flow coming from the driven system.	

Application of cooling systems to the LEROY-SOMER range

Frame size	IC 410/IC 418	IC 411	IC 416
56	●	○	
63	●	○	
71	●	○	
80	●	○	●
90	●	○	●
100	●	○	●
112	●	○	●
132	●	○	●

● : possible ○ : standard construction

Other cooling systems (on request)
 - complete immersion of motor in oil
 - circulation of water inside housing
 - sealed motor submerged in water

Single phase induction motors

Construction

C4.2 - VENTILATION

C4.2.1 - Motor ventilation

In compliance with standard EN 60034-6, the motors in this catalogue are cooled using method IC 411, i.e. "surface-cooled machine using the ambient air circulating round the machine".

Cooling is achieved by a fan mounted at the NDE of the motor, inside a fan cover which acts as a safety guard (control conforming to EN 60034-5). The fan draws the air through the grille in the cover and sends it along the housing fins, giving an identical heat balance in either direction of rotation (except for 2-pole motors with frame size 315).

NB : Obstruction, even accidental, of the fan cover grille (grille clogged or placed against a wall) has an adverse effect on the motor cooling process.



C4.2.2 - Non-ventilated applications in continuous operation

Motors can be supplied without fans. Dimensions will depend on the application.

a) IC 418 cooling system

Placed in the air flow from a fan, these machines are capable of achieving their power rating if the speed of the air between the casing fins and the overall flow rate of the air between them comply with the figures in the table opposite.

Frame size	2 poles		4 poles		6 poles and above	
	flow rate m ³ /h	speed m/s	flow rate m ³ /h	speed m/s	flow rate m ³ /h	speed m/s
56	37	8	16	3.5	-	-
63	50	7.5	23	4	-	-
71	82	7.5	39	4.5	24	2
80	120	7.5	60	4	40	2.5
90	200	11.5	75	5.5	-	-
100	300	15	130	7.5		
112	460	18	200	9		
132	570	21	300	10.5		

These air flows are valid for normal working conditions as described in section B2.1, page 19.

Single phase induction motors Construction

C5 - Mains connection

C5.1 - TERMINAL BOX

Placed as standard on the top of the motor near the drive end, the terminal box has IP 55 protection and is fitted with a cable gland (see table on opposite page)

The standard position of the cable gland is on the right, seen from the drive end.

If required, the terminal box and the cable gland may be fitted in a different position.

▼ *Positions of the terminal box in relation to the drive end*

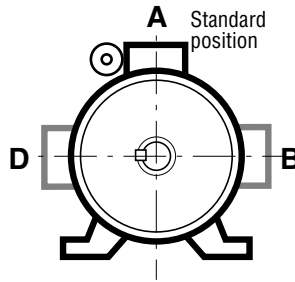

▼ *Positions of the cable gland in relation to the drive end*

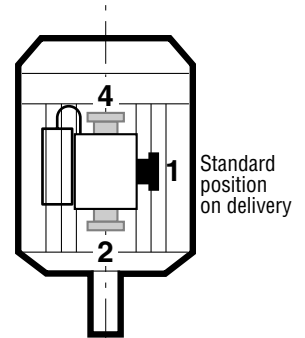

Position 2 not recommended and not possible on standard (FF) flange-mounted motor



Terminal box version P



Terminal box version PR
frame size ≤ 90 mm

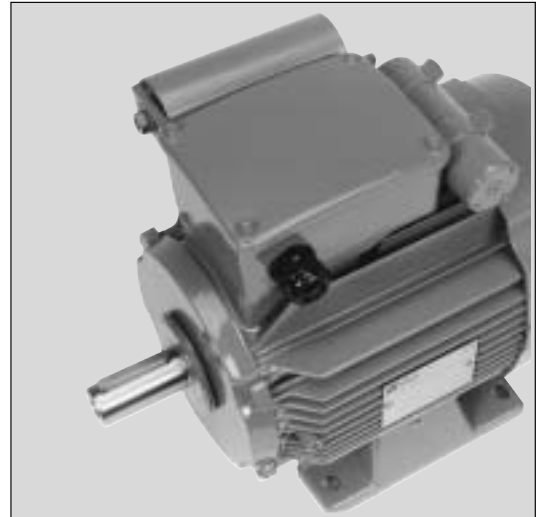

Terminal box version PR
frame size ≥ 100 mm

Flying leads

According to specification, motors can be supplied with flying leads or with the leads in a flexible cable, as an alternative to terminals on a block inside the terminal box. Please state cable characteristics (type and supplier, cross-section, length, number of conductors), method of termination (on stator winding ends, or on a separate panel), and the cable gland position required.



Optional plastic terminal cover
for version P
frame size ≤ 90 mm

Single phase induction motors Construction

C5.2 - TABLE OF TERMINAL BOXES AND CABLE GLANDS FOR RATED SUPPLY VOLTAGE OF 230 V

Frame size	Terminal box material	Cable gland size	Cable gland for accessories : PTO / PTF / etc
56	Aluminium	PE 11	PE 9
63	Aluminium	PE 11	PE 9
71	Aluminium	PE 11	PE 9
80	Aluminium	PE 13	PE 9
90	Aluminium	PE 13	PE 9
100	Aluminium	PE 16	PE 9
112 / 132	Aluminium	PE 16	PE 9
132	Aluminium	PE 21	PE 9

Tightening capacity of cable glands (NFC 68311 and 68312 standards)

Cable gland type	Tightening capacity	
	Min cable Ø (mm)	Max cable Ø (mm)
PE 9	5	8
PE 11	7	10
PE 13	9	12
PE 16	10	14
PE 21	12	18

Material of standard cable gland = plastic (brass, on request).
On request, terminal boxes can be supplied drilled, without cable gland.

Single phase induction motors Construction

C5.3 - TERMINAL BLOCKS - DIRECTION OF ROTATION

Standard motors are fitted with a block of six terminals.

If the motor is fitted with thermal protection or space heaters, these are connected to separate terminals with labelled wires.

Standard motors are designed for forward and reverse operation.

On request, they can be produced as one-way motors. The direction should be specified as seen from the drive end.

Frame size	Single speed single phase motor	
	Number of poles	Terminals
56 to 71	2 - 4 - 6	M4
80 to 90	2 - 4 - 6	M4
100	2 - 4	M5
112 to 132	2 - 4	M6

Tightening torque for the nuts on the terminal blocks. ►

Terminal	M4	M5	M6
Torque N.m	2	3.2	5

C5.4 - WIRING DIAGRAMS

All standard motors are supplied with a wiring diagram in the terminal box.

The diagrams normally used are shown opposite.

On the following pages are outline diagrams with internal and external connections.

Single phase motor with permanent capacitor

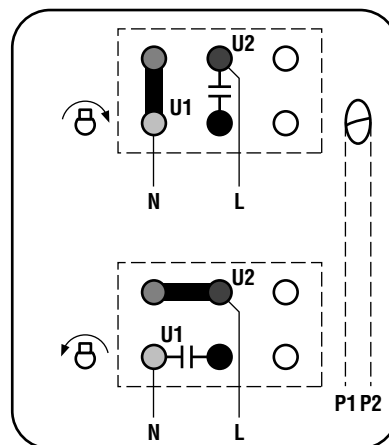

Single phase motor with permanent capacitor + starting capacitor

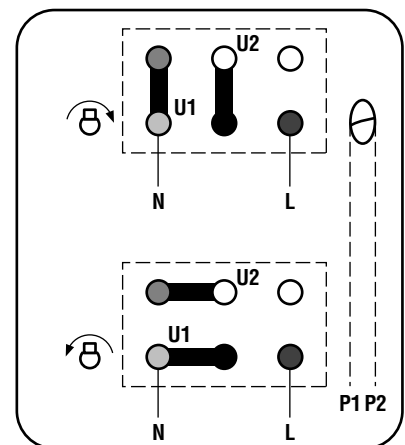

C5.5 - EARTH TERMINAL

This is situated inside the terminal box. It is a threaded stud with a hexagonal nut (and a terminal washer if required) or a TORX T20 recessed head screw (for motors LS 56 to LS 90), and will take cables with cross-sections at least as large as the cross-section of the phase conductors.

It is indicated by the sign : \ominus in the terminal box moulding.

On request, a second earth terminal can be fitted on one of the feet or on one of the cooling fins.



Single phase induction motors Construction

C6 - Motor connections

SINGLE PHASE 1 VOLTAGE - 2 DIRECTIONS - 1 SPEED

Version "P" with permanent capacitor

STANDARD 4-WIRE WINDING

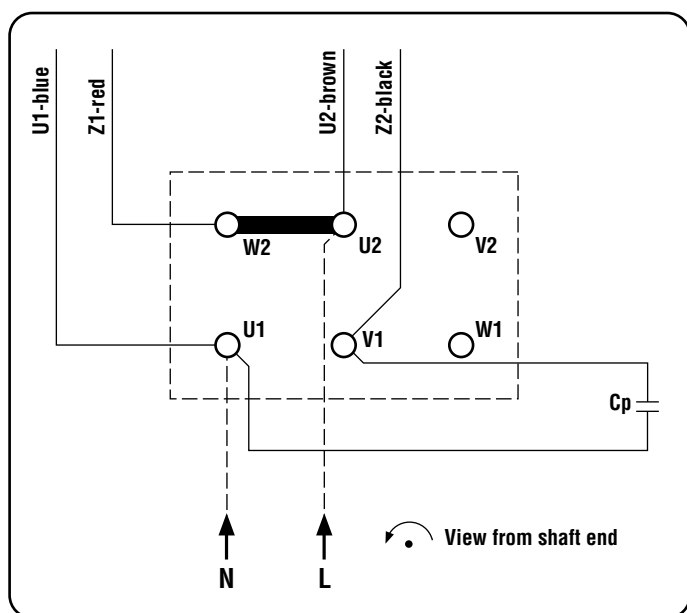
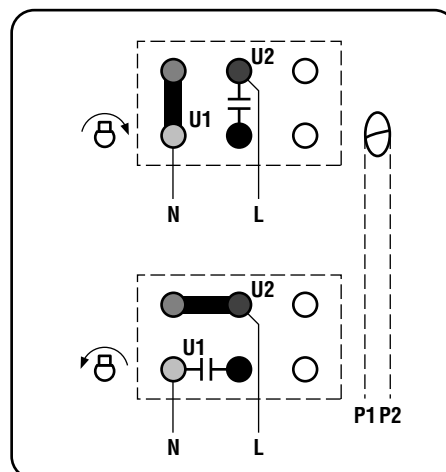
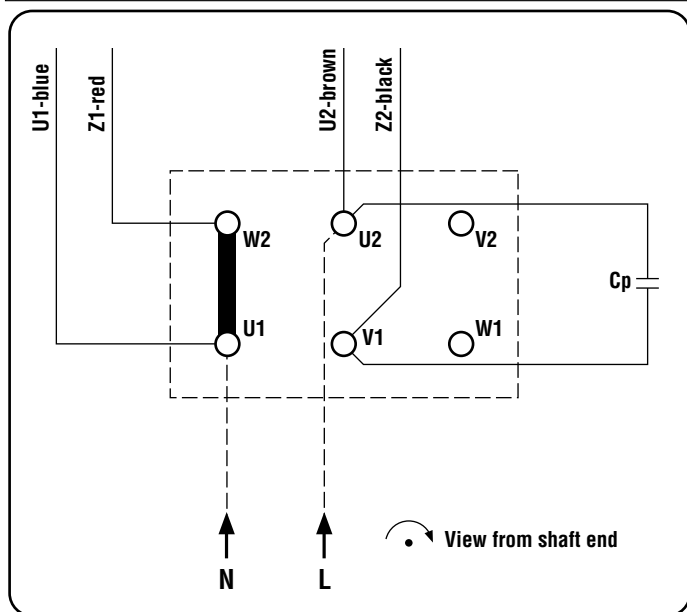

Cp = Permanent capacitor

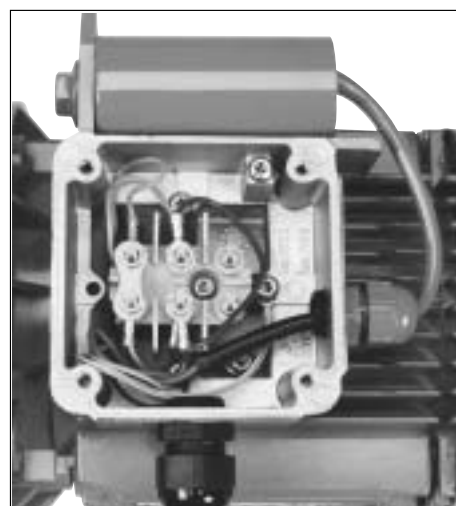

Single phase induction motors Construction

SINGLE PHASE 1 VOLTAGE - 2 DIRECTIONS - 1 SPEED

Version "PR" with permanent capacitor and starting capacitor

C

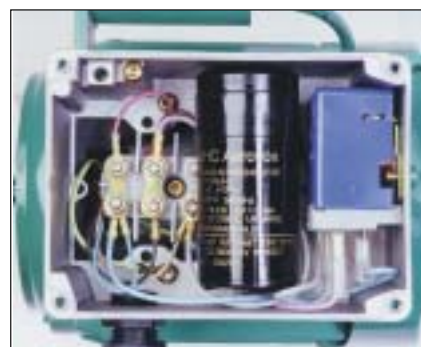
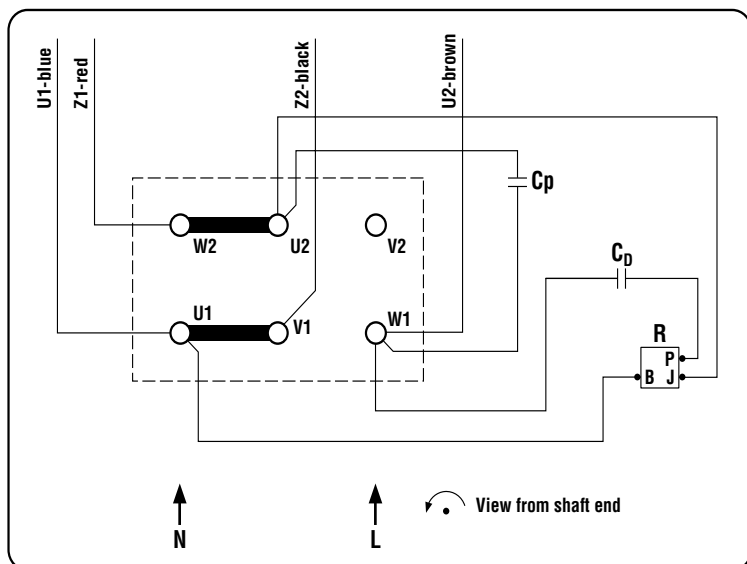
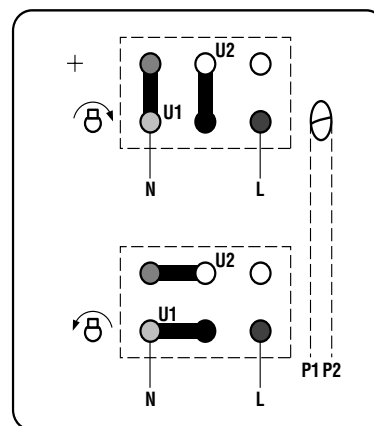
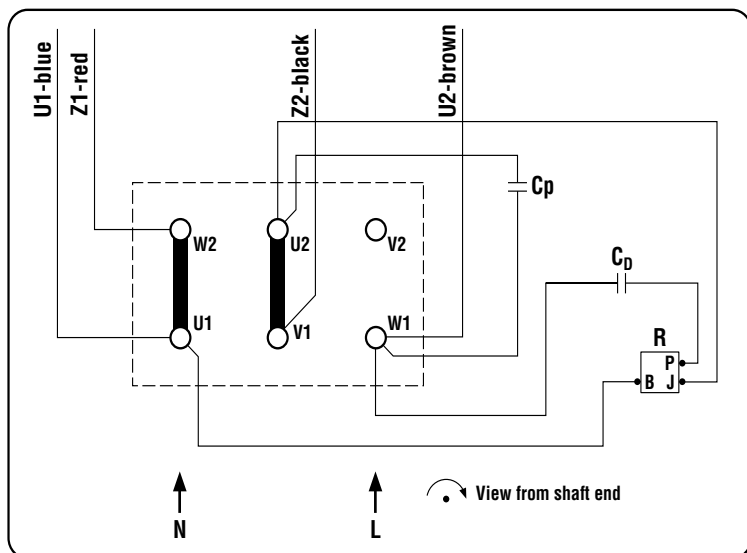

C_p = Permanent capacitor
C_D = Starting capacitor
R = Voltage relay

Single phase induction motors Construction

SINGLE PHASE 1 VOLTAGE - 2 DIRECTIONS - 1 SPEED
Version "P" with permanent capacitor
2-PHASE 3-WIRE WINDING

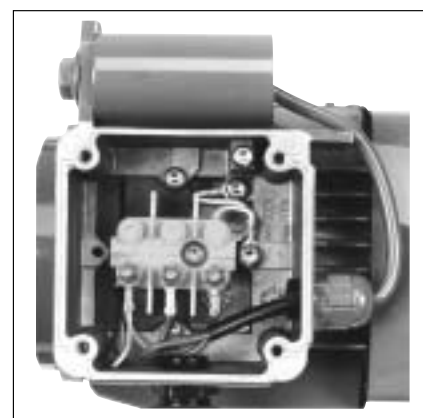
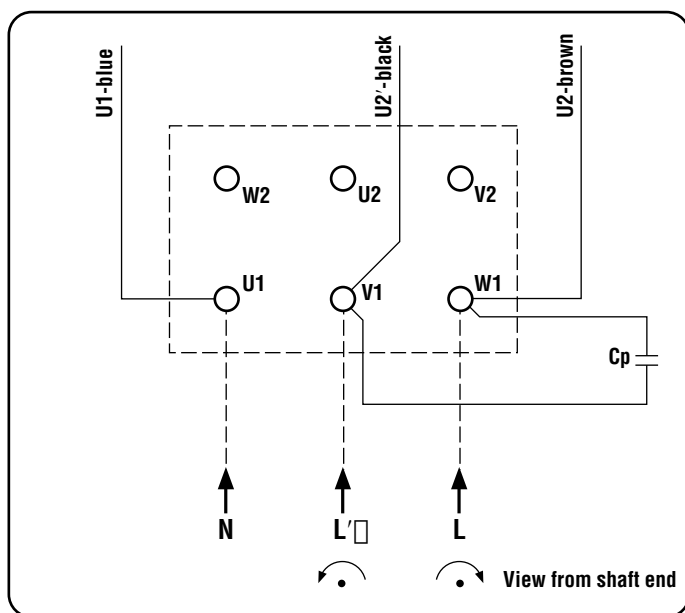
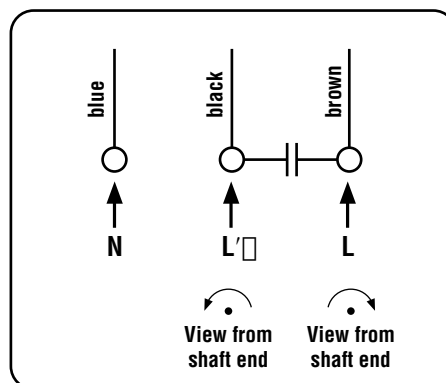
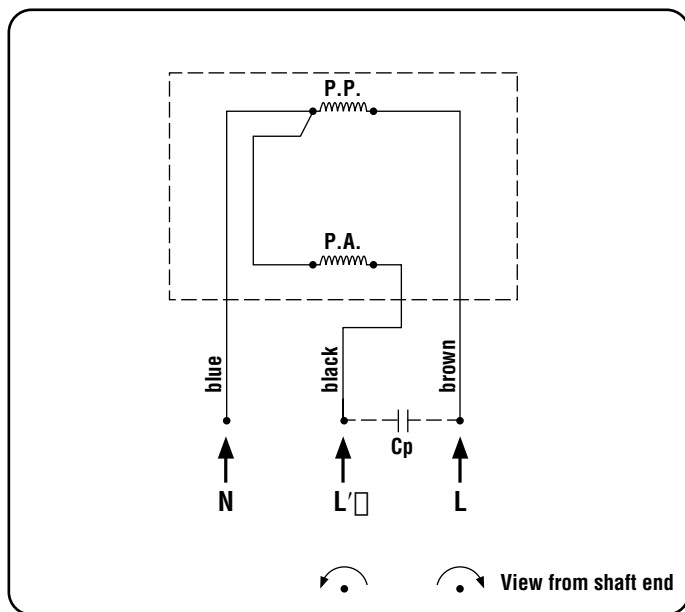

Cp = Permanent capacitor

Single phase induction motors Operation

D1 - Duty cycle - Definitions

Definitions (IEC 34-1)

1 - Continuous duty - Type S1

Operation at constant load for a sufficient amount of time for thermal equilibrium to be reached (see figure 1).

2 - Short-time duty - Type S2

Operation at constant load for a fixed amount of time, less than that required for thermal equilibrium to be reached, followed by a rest and de-energized period long enough to equalize the temperatures of the machine and the coolant to within 2 K (see figure 2).

3 - Intermittent periodic duty - Type S3

A succession of identical duty cycles, each containing a period of operation at constant load and a rest and de-energized period (see figure 3). Here, the cycle is such that the starting current does not significantly affect the temperature rise (see figure 3).

4 - Intermittent periodic duty with starting - Type S4

A succession of identical duty cycles consisting of an appreciable starting period, a period of operation at constant load and a rest and de-energized period (see figure 4).

5 - Intermittent periodic duty with electrical braking - Type S5

A succession of periodic duty cycles, each containing a starting period, a period of operation at constant load, a period of rapid electrical braking and a rest and de-energized period (see figure 5).

6 - Periodic continuous duty with intermittent load - Type S6

A succession of identical duty cycles, each containing a period of operation at constant load and a period of operation at no-load. There is no rest and de-energized period (see figure 6).

7 - Periodic continuous duty with electrical braking - Type S7

A succession of identical duty cycles, each containing a starting period, a period of operation at constant load and a period of electrical braking. There is no rest and de-energized period (see figure 7).

8 - Continuous-operation periodic duty with related changes of load and speed - Type S8

A succession of identical duty cycles, each containing a period of operation at constant load corresponding to a predetermined

rotation speed, followed by one or more periods of operation at other constant loads corresponding to different rotation speeds (in induction motors, this can be done by changing the number of poles). There is no rest and de-energized period (see figure 8).

9 - Duty with non-periodic variations in load and speed - Type S9

This is a duty in which the load and speed generally vary non-periodically within the permissible operating range. This duty frequently includes applied overloads which may be much higher than the full load or loads (see figure 9).

Note: for this type of duty, the appropriate full load values must be used as the basis for calculating overload.

10 - Operation at distinct constant loads - Type S10

This duty consists of a maximum of 4 distinct load values (or equivalent loads), each value being applied for sufficient time for the machine to reach thermal equilibrium. The minimum load during a load cycle may be zero (no-load operation or rest and de-energized period) (see figure 10).

NB : In section D4.6, there is a method for specifying machines in intermittent duty.

▼ Fig. 1. - Continuous duty, Type S1.

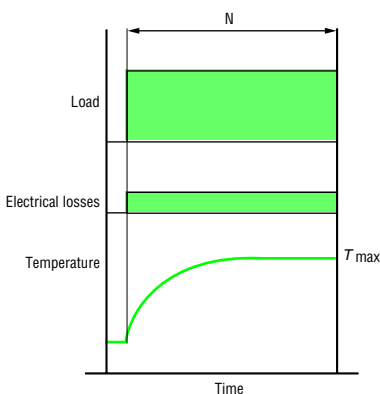

N = operation at constant load
 T_{max} = maximum temperature attained

▼ Fig. 2. - Short-time duty, Type S2.

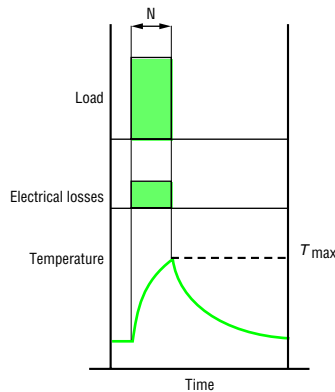

N = operation at constant load
 T_{max} = maximum temperature attained

▼ Fig. 3. - Intermittent periodic duty, Type S3.

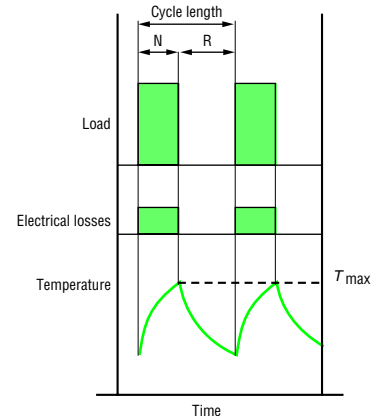

N = operation at constant load
 R = rest
 T_{max} = maximum temperature attained

$$\text{Operating factor} = \frac{N}{N + R} \times 100$$

Single phase induction motors Operation

▼ Fig. 4. - Intermittent periodic duty with starting, Type S4.

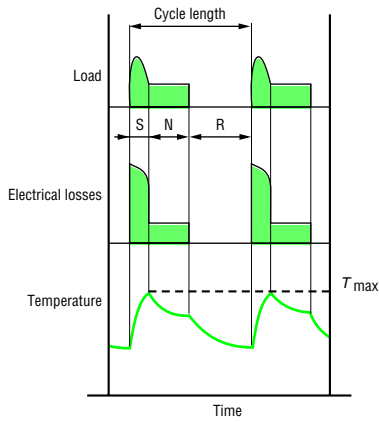

D = starting
 N = operation
 R = rest
 T_{max} = maximum temperature attained during cycle
 Operating factor = $\frac{D + N}{N + R + D} \times 100$

▼ Fig. 5. - Intermittent periodic duty with electrical braking, Type S5.

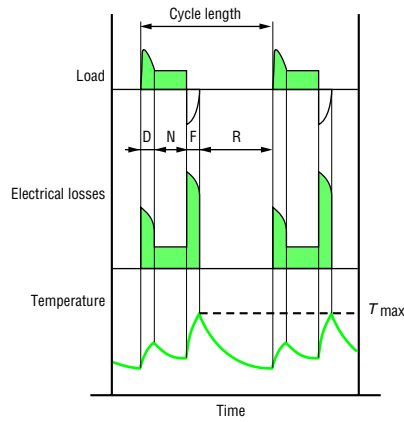

D = starting
 N = operation
 F = electrical braking
 R = rest
 T_{max} = maximum temperature attained during cycle
 Operating factor = $\frac{D + N + F}{D + N + F + R} \times 100$

▼ Fig. 6. - Periodic continuous duty with intermittent load, Type S6.

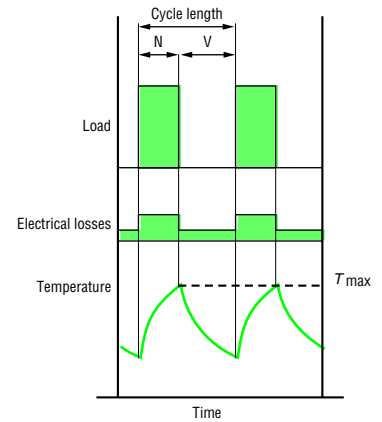

N = operation at constant load
 V = off-load operation
 T_{max} = maximum temperature attained during cycle
 Operating factor = $\frac{N}{N + V} \times 100$

▼ Fig. 7. - Periodic continuous duty with electrical braking, Type S7.

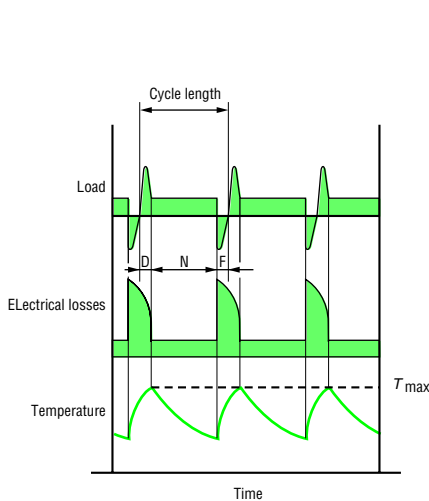

D = starting
 N = operation at constant load
 F = electrical braking
 T_{max} = maximum temperature attained during cycle
 Operating factor = 1

▼ Fig. 8. - Continuous-operation periodic duty with related changes of load and speed, Type S8.

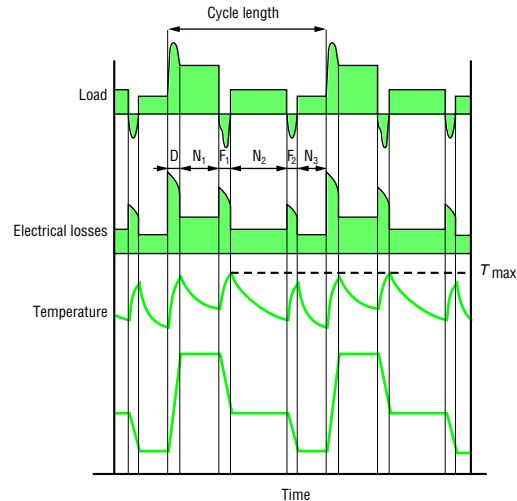

F1F2 = electrical braking
 D = starting
 N1N2N3 = operation at constant loads.
 T_{max} = maximum temperature attained during cycle
 Operating factor = $\frac{D + N1}{D + N1 + F1 + N2 + F2 + N3} \times 100\%$
 $\frac{F1 + N2}{D + N1 + F1 + N2 + F2 + N3} \times 100\%$
 $\frac{F2 + N3}{D + N1 + F1 + N2 + F2 + N3} \times 100\%$

Single phase induction motors Operation

▼ Fig. 9. - Duty with non-periodic variations in load and speed, Type S9.

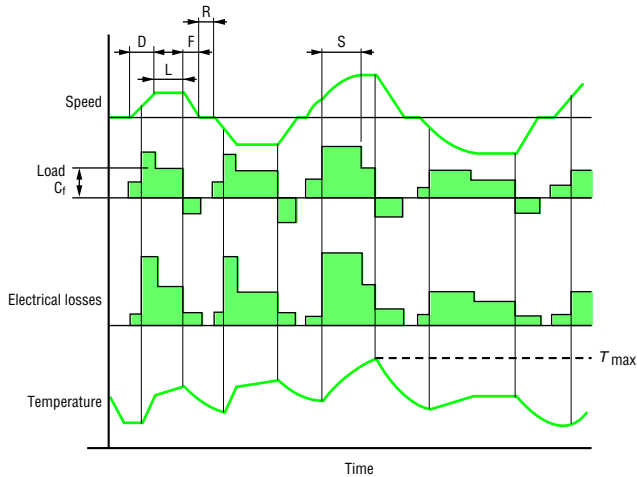

- D = starting.
- L = operation at variable loads.
- F = electrical braking.
- R = rest.
- S = operation at overload.
- C_f = full load.
- T_{max} = maximum temperature attained.

▼ Fig. 10. - Duty at distinct constant loads, Type S10.

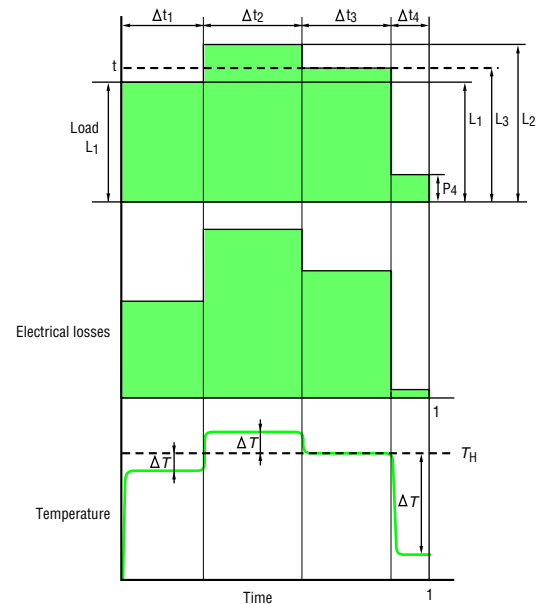

- L = load.
- N = power rating for duty type S1
- $p = p / \frac{L}{N}$ = reduced load.
- t = time.
- T_p = total cycle time.
- t_i = distinct period within a cycle.
- $\Delta t_i = t_i / T_p$ = relative duration of period within a cycle.
- P_u = electrical losses.
- H_N = temperature at power rating for duty type S1.
- ΔH_i = increase or decrease in temperature rise at the i^{th} period of a cycle.

Note : Power is determined according to duty cycle. See section D4.6.

Single phase induction motors Operation

D2 - Supply voltage

D2.1 - REGULATIONS AND STANDARDS

The statement by the electricity consultative committee dated 25th June 1982, and the 6th edition (1983) of publication No. 38 of the International Electrotechnical Committee (IEC) have laid down time scales for the harmonisation of standard voltages in Europe.

Since 1998, voltages at the point of delivery

have to be maintained between the following extreme values:

- **Single phase current: 207 to 244 V**

The IEC 38 standard gives the European reference voltage as 230/400V three-phase, 230V single phase, with a tolerance of +6% to -10% until 2003, and $\pm 10\%$ from then on.

Supply voltage ranges : In normal operating conditions, it is recommended that voltage variations at the point of delivery should not differ from the rated supply voltage by more than $\pm 10\%$.

In accordance with IEC 34-1, voltage ranges for single phase motors are $\pm 5\%$ of the rated voltage.

SECTION TWO - TABLES OF STANDARD VOLTAGES

Table I

A.C. systems having a nominal voltage between 100 V and 1000 V inclusive and related equipment

In the following table, the three-phase, four-wire systems and single-phase three-wire systems include single-phase circuits (extensions, services, etc.) connected to these systems.

The lower values in the first and second columns are voltages to neutral and the higher values are voltages between phases. When only one value is indicated, it refers to three-wire systems and specifies the voltage between phases. The lower value in the third column is the voltage to neutral and the higher value is the voltage between lines.

The voltages in excess of 230/400 V are intended exclusively for heavy industrial applications and large commercial premises.

Three-phase 3- or 4-wire systems		Single-phase 3-wire systems
Nominal voltage		Nominal voltage
V		V
50 Hz	60 Hz	60 Hz
-	120/208	120/240
-	240	-
230/400 ¹	277/480	-
400/690 ¹	480	-
-	347/600	-
1 000	600	-

1. The nominal voltage of 220/380 V and 240/415 V systems should evolve towards the recommended value of 230/400 V. The transition period should be as short as possible and should not exceed the year 2003. During this period, as a first step, the electricity supply authorities of countries having 220/380 V systems should bring the voltage within the range 230/400 V + 6%, - 10% and those of countries having 240/415 V systems should bring the voltage within the range 230/400 V + 10%, - 6%. At the end of this transition period the tolerance of 230/400 V $\pm 10\%$ should have been achieved; reduction of this range should be envisaged thereafter. All the above considerations apply also to the present 370/600 V value with respect to the recommended value 400/690 V.

230 V



Single phase induction motors

Operation

D3 - Insulation class

Insulation class

The machines in this catalogue have been designed with a Class F insulation system for the windings.

At rated voltage, class F allows for temperature rises of 105 K (measured by the resistance variation method) and maximum temperatures of 155 °C at the hot spots in the machine (see IEC 85 and EN 60034-1). Complete impregnation with tropicalized varnish of thermal class 180 °C gives protection against attacks from the environment, such as 90% relative humidity, etc.

For special constructions, the winding is of class H and impregnated with special varnishes which enable it to operate in conditions of high temperatures with relative air humidity of up to 100%.

Temperature rise (ΔT^*) and maximum temperatures at hot spots (T_{max}) for insulation classes (EN 60034-1).

	ΔT^*	T_{max}
Class F	105 K	155 °C
Class H	125 K	180 °C

* Measured using the winding resistance variation method.

The insulation of the windings is monitored in two ways :

a - Dielectric inspection which involves checking the leakage current, at an applied voltage of $(2U + 1000)$ V, in conditions complying with the EN 60034-1 standard (systematic test).

b - Monitoring the insulation resistance between the windings and between the windings and the earth (sampling test) at a D.C. voltage of 500V or 1000V.



D4 - Power - Torque - Efficiency - Power Factor - Cos φ

D4.1 - DEFINITIONS

The output power (P_u) at the motor shaft is linked to the torque (M) by the equation :

$$P_u = M \cdot \omega$$

where P_u is in W, M is in Nm, ω is in rad/s and where ω is expressed as a function of the speed of rotation N in min^{-1} by the equation :

$$\omega = 2\pi \cdot N/60$$

The active power (P) drawn from the mains supply is expressed as a function of the apparent power (S) and the reactive power (Q) in the equation :

$$S = \sqrt{P^2 + Q^2} = U \cdot I$$

(S in VA, P in W and Q in VAR)

The apparent power on starting is also expressed as :

$$S = U \cdot I_D$$

which can be used to calibrate connection devices and/or determine the alternator short-circuit power.

The power P drawn from the mains supply is linked to the output power P_u by the equation :

$$P = \frac{P_u}{\eta}$$

where η is the efficiency of the machine.

The output power at the drive shaft is expressed as a function of the phase-to-phase mains voltage (U), of the line current absorbed (I in amps) in the equation :

$$P_u = U \cdot I \cdot \cos \varphi \cdot \eta$$

where $\cos \varphi$ is the power factor found from the ratio :

$$\cos \varphi = \frac{P}{S} = \frac{P}{U \cdot I}$$

D4.2 - INFLUENCE OF MOTOR LOAD ON POWER FACTOR COS φ AND EFFICIENCY

The efficiency and $\cos \varphi$ change depending on the motor load.

Single phase induction motors Operation

D4.3 - TORQUE - SPEED CHARACTERISTICS

Version "P" with permanent capacitor

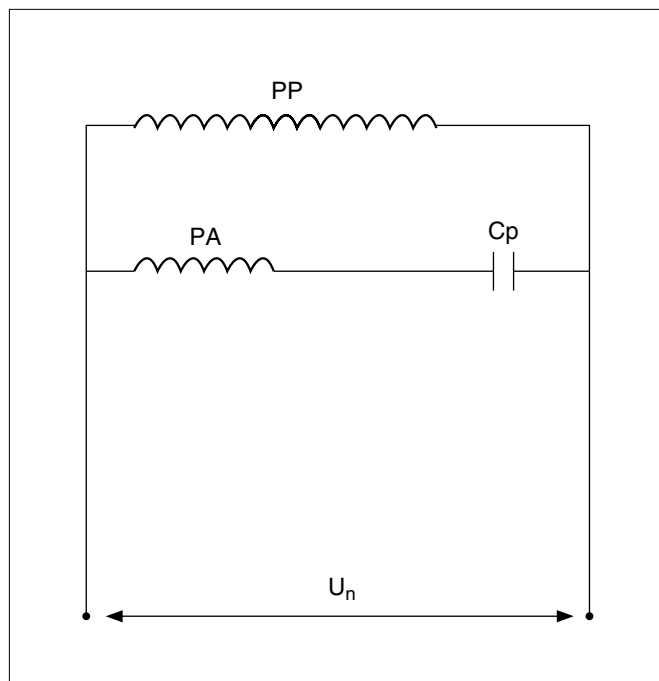
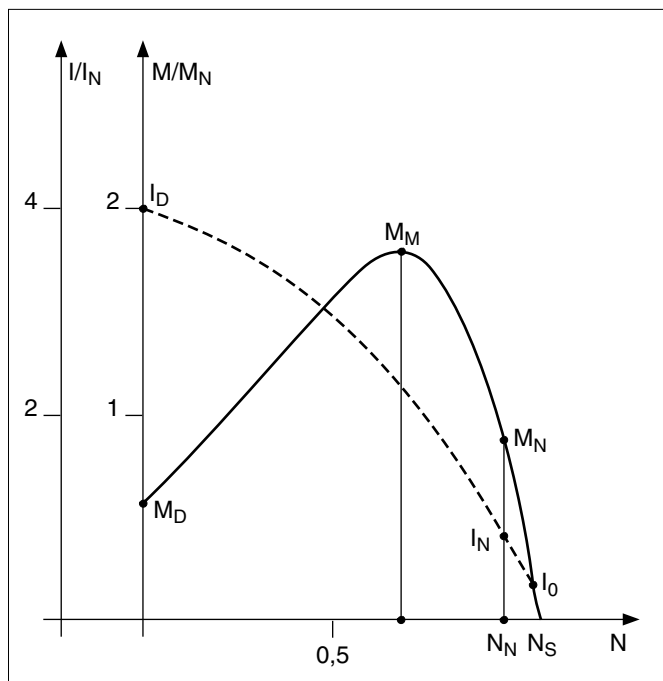

Version "PR" with permanent capacitor and starting capacitor

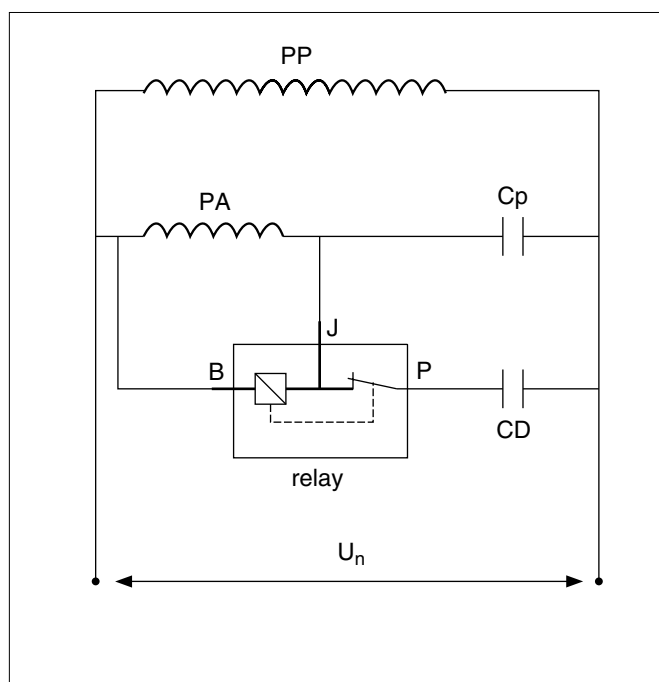
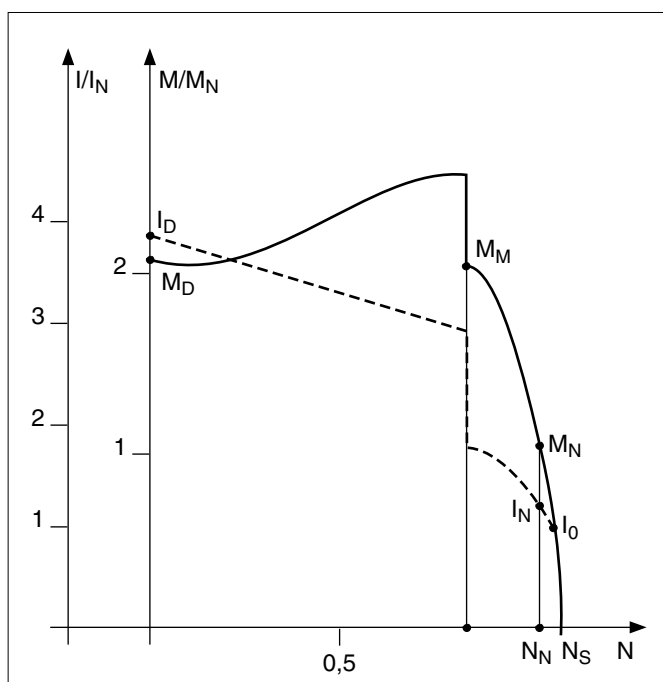

Single phase induction motors Operation

D4.4 - CALCULATION OF ACCELERATING TORQUE AND STARTING TIME

Acceleration time can be calculated using a simplified formula:

$$t_d = \frac{\pi}{30} \frac{N \cdot J_N}{M_a}, \text{ where :}$$

t_d : is the starting time in seconds;

J_N is the moment of inertia in $\text{kg} \cdot \text{m}^2$ of the motor plus the load, corrected, if necessary, to the speed of the shaft which develops the torque M_a .

N is the speed to be achieved in min^{-1} ;

M_a or M_{acc} is the average accelerating torque in $\text{N} \cdot \text{m}$ (average torque developed by the motor during starting, reduced by the average load torque during the same period). In general, for centrifugal machines, a very good approximation can be written as follows :

$$M_a = \frac{M_D + 2M_A + 2M_M + M_N}{6} - M_r$$

The chart below may also be used :

Example: A mass with a moment of inertia of $J : 9.6 \text{ kg} \cdot \text{m}^2$ is accelerated by a torque of $10 \text{ N} \cdot \text{m}$ up to a speed of 100 min^{-1} .

The acceleration time will be:
 $t = 10 \text{ seconds}$

Here again is the formula by which the moment of inertia of the driven machine turning at speed N' is equalized with the speed N of the motor.

$$J_N = J \cdot \left(\frac{N'}{N}\right)^2$$

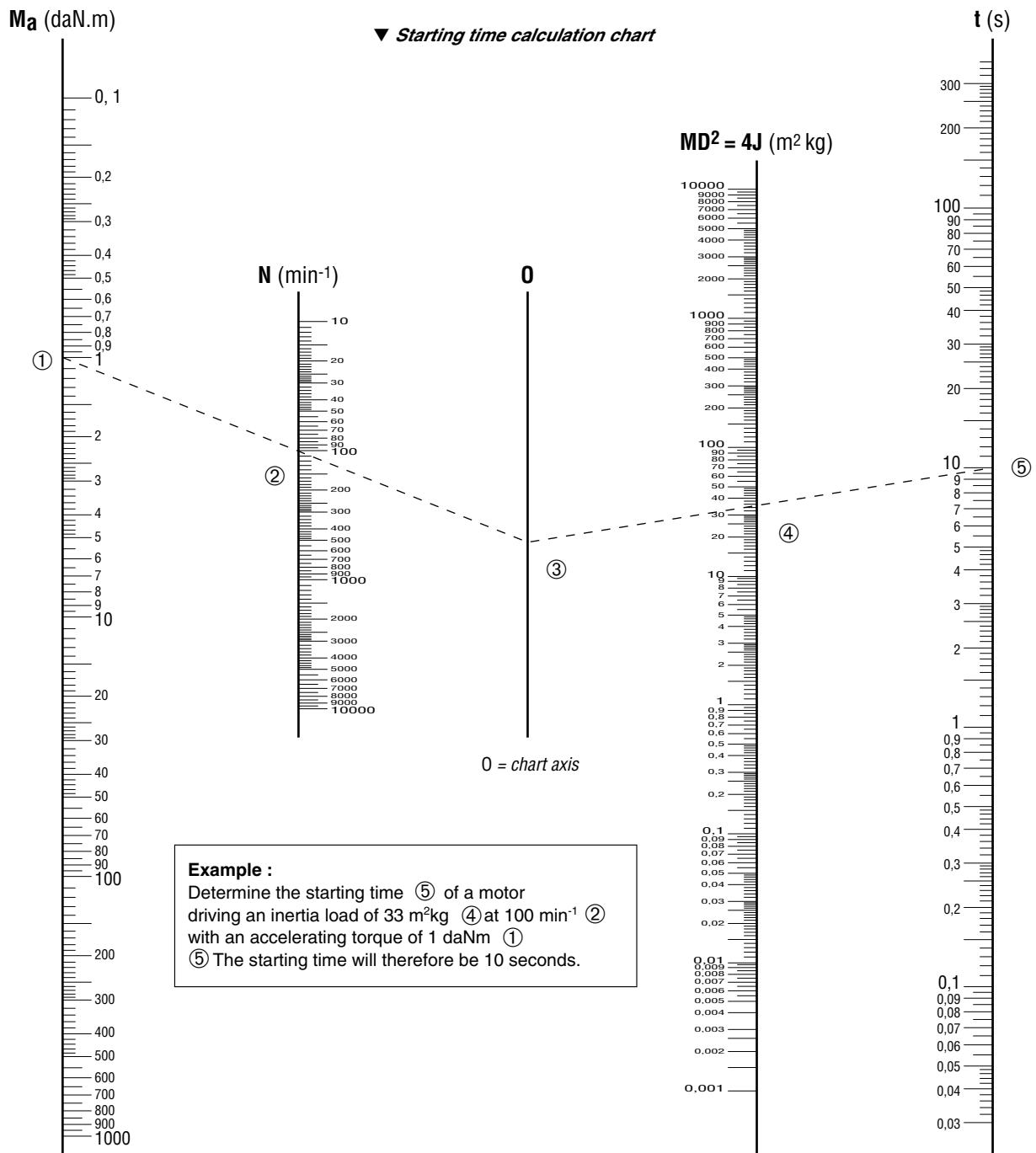

Single phase induction motors

Operation

D4.5 - RATED POWER P_n IN RELATION TO DUTY CYCLE

D4.5.1 - General rules for standard motors

$$P_n = \sqrt{\frac{n \times t_d \times [I_D/I_n \times P]^2 + (3600 - n t_d) P_u \times f_{dm}}{3600}}$$

Iterative calculation where :

t_d (s) starting time of motor with power P (w)

n number of (equivalent) starts per hour

f_{dm} operating factor (decimal)

I_D/I_n starting current of motor with power P

P_u (w) output power of motor during the duty cycle using OF (in decimal) operating factor

P (w) rated power of motor selected for the calculation

Note : n and OF are defined in sect. D4.5.2. Sp = specification

S1	OF = 1 ; $n \leq 6$
S2	; $n = 1$ length of operation determined by Sp
S3	OF according to Sp ; $n \sim 0$ (temperature rise not affected by starting)
S4	OF according to Sp ; n acc.to Sp ; t_d, P_u, P according to Sp (replace n with $4n$ in the above formula)
S5	OF according to Sp ; $n = n$ starts + $3 n$ brakings = $4 n$; t_d, P_u, P acc. to Sp (replace n with $4n$ in the above formula)
S6	$P = \sqrt{\frac{\sum (P_i^2 \cdot t_i)}{\sum t_i}}$
S7	same formula as S5 but OF = 1
S8	at high speed, same formula as S1 at low speed, same formula as S5
S9	S8 duty formula after complete description of cycle with OF on each speed
S10	same formula as S6

In addition, see the warning regarding precautions to be taken. Variations in voltage and/or frequency greater than standard should also be taken into account. Applications (general at constant torque, centrifugal at quadratic torque, etc) should also be taken into account.

D4.5.2 - Power for intermittent duty cycles for adapted motor rms power in intermittent duty

This is the rated power drawn by the driven machine and is generally determined by the manufacturer.

If the power drawn by the machine varies during a cycle, the rms power P is calculated using the equation :

$$P = \sqrt{\frac{\sum_1^n (P_i^2 \cdot t_i)}{\sum_1^n t_i}} = \sqrt{\frac{P_1^2 \cdot t_1 + P_2^2 \cdot t_2 + \dots + P_n^2 \cdot t_n}{t_1 + t_2 + \dots + t_n}}$$

if, during the working time the power drawn is:

$$\begin{matrix} P_1 & \text{for period } t_1 \\ P_2 & \text{for period } t_2 \\ \dots & \dots \\ P_n & \text{for period } t_n \end{matrix}$$

Power values lower than 0.5 P_N are replaced by 0.5 P_N in the calculation of rms power P (no-load operation is a special case).

Additionally, it is also necessary to check that, for a particular motor of power P_N ,

- the actual starting time is at most equal to 5 seconds,
- the maximum output of the cycle does not exceed twice the rated output power P
- there is still sufficient accelerating torque during the starting period.

Load factor (LF)

Expressed as a percentage, this is the ratio of the period of operating time with a load during the cycle to the total duration of the cycle where the motor is energized.

Operating factor (OF)

Expressed as a percentage, this is the ratio of the period of actual operating time to the total duration of the cycle, provided that the total cycle is shorter than 10 minutes.

Starting class

Class: : $n = n_0 + k \cdot n_F + k' \cdot n_i$

n_0 is the number of complete starts per hour;

n_F is the number of times electrical braking is applied per hour;

"Electrical braking" means any braking directly involving the stator winding or the rotor winding:

- Regenerative braking (with frequency controller, multipole motor, etc).
- Reverse-current braking (the most commonly used).
- D.C. injection braking.

n_i is the number of impulses (incomplete starts of up to one-third of maximum speed) per hour.

k and k' are constants determined as follows :

	k	k'
Cage induction motors	3	0.5

- Reversing the rotational direction involves braking (generally electrical) and starting.

- Braking with LEROY-SOMER electro-mechanical brakes, as with any other brakes that are independent of the motor, does not constitute electrical braking in the sense described above.

Calculating derating

- Input criteria (load)
 - rms power during cycle = P
 - Moment of inertia corrected to speed of motor : J_e
 - Operating factor = OF
 - Class of starts per hour = n
 - Resistive torque during starting M_r
- Selection in catalogue
 - motor power rating = P_N
 - starting current $I_d, \cos\phi_D$
 - Moment of inertia of rotor J_r
 - Average starting torque M_{mot}
 - Efficiency at P_N (η_{P_N}) and at P (η_P)

Calculations

- Starting time :

$$t_d = \frac{\pi}{30} \cdot N \cdot \frac{(J_e + J_r)}{M_{mot} - M_r}$$

- Cumulative starting time per hour : $n \times t_d$

- Energy to be dissipated per hour during starts = sum of the energy dissipated in the rotor (= inertia acceleration energy) and the energy dissipated in the stator during the cumulative starting time per hour :

$$E_d = \frac{1}{2} (J_e + J_r) \left(\frac{\pi \cdot N}{30} \right)^2 \times n + n t_d \sqrt{3} U I_d \cos\phi_d$$

- Energy to be dissipated during operation

$$E_f = P \cdot (1 - \eta_P) \cdot (FM \times 3600 - n t_d)$$

- Energy that the motor can dissipate at rated power with the Operating Factor for Intermittent Duty.

$$E_m = (FM) 3600 \cdot P_N \cdot (1 - \eta_{P_N})$$

(The heat dissipated when the motor is at rest can be ignored).

Dimensioning is correct if the following relationship is verified = $E_m \geq E_d + E_f$

If the sum of $E_d + E_f$ is lower than 0.75 E_m check whether a motor with the next lowest power would be more suitable.

D4.5.3 - Equivalent thermal constant

The equivalent thermal constant enables the machine cooling time to be pre-determined.

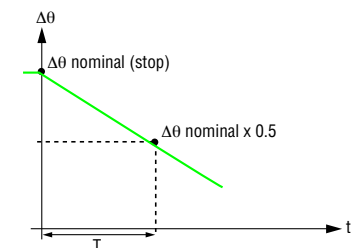

$$\text{Thermal constant} = \frac{T}{\ln 2} = 1.44 T$$

Cooling curve $\Delta\theta = f(t)$

where $\Delta\theta$ = temperature rise in S1 duty

T = time required for nominal temperature rise to reach half its value

t = time

\ln = natural logarithm

Single phase induction motors Operation

D5 - Noise and vibration

D5.1 - MOTOR NOISE LEVELS

D5.1.1 - Noise emitted by rotating machines

In a compressible medium, the mechanical vibrations of an elastic body create pressure waves which are characterized by their amplitude and frequency. The pressure waves constitute an audible noise if they have a frequency of between 16 and 16000 Hz.

Noise is measured by a microphone linked to a frequency analyzer. Measurements are taken in an anechoic chamber on machines at no-load, and a sound pressure level L_p or a sound power level L_w can then be established. Measurement can also be carried out in situ on machines which may be on-load, using an acoustic intensity meter which can differentiate between sound sources and identify the sound emissions from the machine.

The concept of noise is linked to hearing. The auditory sensation is determined by integrating weighted frequency components with isosonic curves (giving a sensation of constant sound level) according to their intensity.

The weighting is carried out on sound meters using filters whose bandwidth takes into account, to a certain extent, the physiology of the human ear:

Filter A : used for low and medium noise levels. High attenuation, narrow bandwidth

Filter B : used for very high noise levels. Wide bandwidth.

Filter C : very low attenuation over the whole of the audible frequency range. Filter A is used most frequently for sound levels emitted by rotating machinery, and with which standardized characteristics are established.

A few basic definitions :

The unit of reference is the bel, and the sub-multiple decibel (dB) is used here.

Sound pressure level in dB

$$L_p = 20 \log_{10} \left(\frac{P}{P_0} \right) \text{ with } P_0 = 2 \cdot 10^{-5} \text{ Pa}$$

Sound power level in dB

$$L_w = 10 \log_{10} \left(\frac{P}{P_0} \right) \text{ with } P_0 = 10^{-12} \text{ W}$$

Sound intensity level in dB

$$L_w = 10 \log_{10} \left(\frac{I}{I_0} \right) \text{ with } I_0 = 10^{-12} \text{ W/m}^2$$

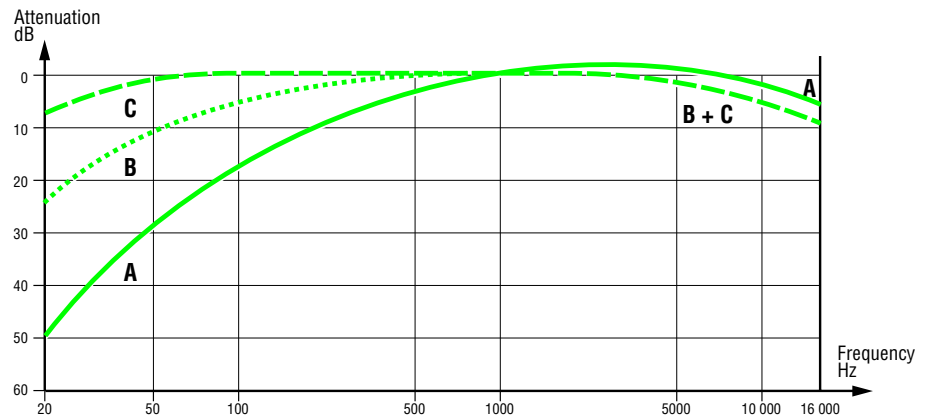

Correction of measurements

For differences of less than 10 dB between two sound sources or where there is background noise, corrections can be made by addition or subtraction using the rules below.

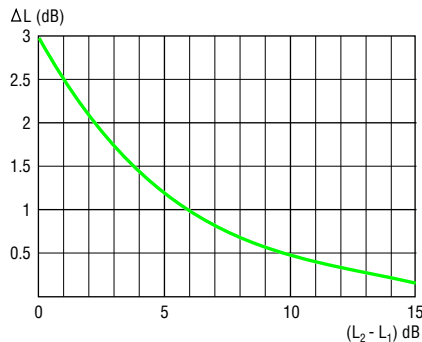

Addition

If L_1 and L_2 are the separately measured levels ($L_2 \geq L_1$), the resulting sound level L_R will be obtained by the formula :

$$L_R = L_2 + \Delta L$$

ΔL is found by using the curve above ▲

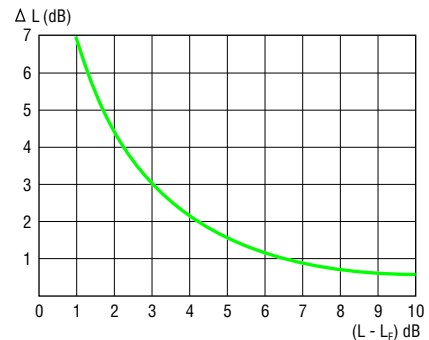

Subtraction*

This is most commonly used to eliminate background noise from measurements taken in a "noisy" environment.

If L is the measured level and L_f the background noise level, the actual sound level L_R will be obtained by the calculation :

$$L_R = L - \Delta L$$

ΔL is found by using the curve above ▲

* This method is the one normally used for measuring sound power and pressure levels. It is also an integral part of sound intensity measurement.

Single phase induction motors

Operation

Under IEC 34-9, the guaranteed values are given for a machine operating at no-load under normal supply conditions (IEC 34-1), in the actual operating position, or sometimes in the direction of rotation as specified in the design.

This being the case, standardized sound power level limits are shown for the values obtained for the machines described in this catalogue. (Measurements were taken in accordance with standards ISO 1680-1 and 1680-2).

Weighted sound level [dB(A)] of motors in position IM 1001 with a 50 Hz supply

Expressed as sound power level (L_w) according to the standard, the level of sound is also shown as sound pressure level (L_p) in the table below :

Motor type	2 poles		4 poles		6 poles	
	LS	LS	LS	LS	LS	LS
	Power L _w A	Pressure L _p A	Power L _w A	Pressure L _p A	Power L _w A	Pressure L _p A
LS 56	68	60	58	50	-	-
LS 63	66	58	64	56	-	-
LS 71	70	62	69	61	69	61
LS 80	75	67	68	60	68	60
LS 90	80	72	77	69	-	-

The maximum standard tolerance for all these values is + 3 dB(A)



Single phase induction motors Operation

The LS machines in this catalogue are classed N

D5.2 - VIBRATION LEVELS - BALANCING

Inaccuracies due to construction (magnetic, mechanical and air-flow) lead to sinusoidal or pseudo-sinusoidal vibrations in a wide range of frequencies. Other sources of vibration can also affect motor operation, such as incorrect mounting, incorrect drive coupling, end shield misalignment and so on.

We shall first of all look at the vibrations emitted at the operating frequency, corresponding to an unbalanced load whose amplitude swamps all other frequencies and on which the dynamic balancing of the mass in rotation has a decisive effect.

Under standard ISO 8821, rotating machines can be balanced with or without a key or with a half-key on the shaft extension.

ISO 8821 requires the balancing method to be marked on the shaft extension as follows:

- half-key balancing : letter H
- full key balancing : letter F
- no-key balancing : letter N

The machines in this catalogue are classed N. Classes R and S are available on request.

▲ *Measuring system for suspended machines* ▲ *Measuring system for machines on flexible mountings.*

The measurement points quoted in the standards are the ones indicated in the drawings above.
At each point, the results should be lower than those given in the tables below for each balancing class, and only the highest value is to be taken as the "vibration level".

Measured parameters

The vibration speed can be chosen as the variable to be measured. This is the speed at which the machine moves either side of its static position.

As the vibratory movements are complex and non-harmonic, it is the quadratic average (rms value) of the speed of vibration which is used to express the vibration level.

Other variables that could be measured are the vibratory displacement amplitude (in microns) or vibratory acceleration (in m/s^2).

If the vibratory displacement is measured against frequency, the measured value decreases with the frequency: high frequency vibrations are not taken into account.

If the vibratory acceleration is measured against frequency, the measured value increases with the frequency: low frequency vibrations (unbalanced loads) are not taken into account.

The rms speed of vibration is the variable chosen by the standards.

However, if preferred, the table of vibration amplitudes may still be used for measuring sinusoidal and similar vibrations.

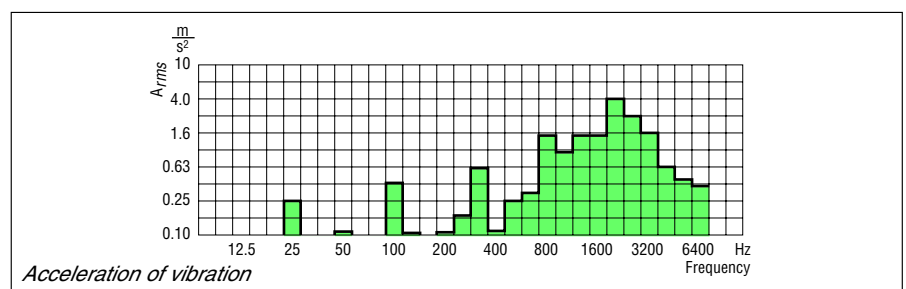
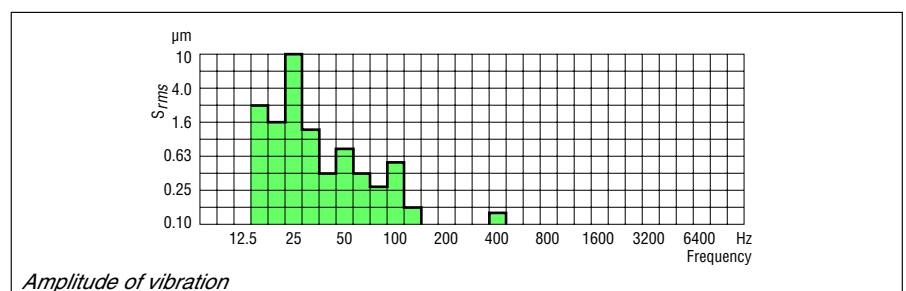
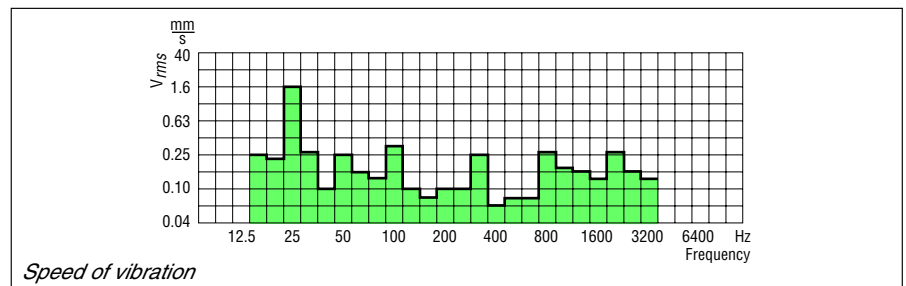

Single phase induction motors Operation

D6 - Performance



D6.1 - THERMAL PROTECTION

Motors are protected by a manual or automatic overcurrent relay, sited between the isolating switch and the motor. This relay may in turn be protected by fuses. These features provide total protection against non-transient overloads. If a shorter reaction time is required, or if you want to

detect transient overloads, or monitor temperature rises at "hot spots" in the motor or at strategic points in the installation for maintenance purposes, it would be advisable to install heat sensors. The various types are shown in the table below, with a description of each. It must be

emphasized that sensors cannot be used to carry out direct adjustments to the motor operating cycle.

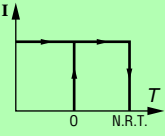
Thermal protection, built-in.

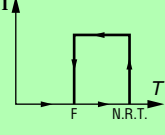
Type	Operating principle	Operating curve	Cut-off (A)	Protection provided	Mounting Number of devices*
Normally closed thermostat PTO	bimetallic strip, indirectly heated, with normally closed contact (NC) 		2.5 A at 250 v with $\cos \varphi$ 0.4	non-transient overloads	Mounting in control circuit 1 or 2 in series
Normally open thermostat PTF	bimetallic strip, indirectly heated, with normally open contact (NO) 		2.5 A at 250 v with $\cos \varphi$ 0.4	non-transient overloads	Mounting in control circuit 1 or 2 in parallel

Direct thermal protection, built-in.

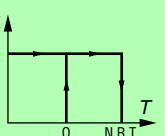
Type	Operating principle	Operating curve	Cut-off (A)	Protection provided	Mounting Number of devices*
Normally closed thermostat PTO with automatic or manual reset	bimetallic strip, directly heated, with normally closed contact (NC) 		Calibration depending on power and operating conditions	non-transient overloads and/or transient overloads	Mounting in energy circuit 1 in series with winding

Single phase induction motors Selection tables

PAGES

E1 - Selection data : SINGLE SPEED

58

2 poles - 3000 min ⁻¹	58 - 59
4 poles - 1500 min ⁻¹	60 - 61
6 poles - 1000 min ⁻¹	60 - 61

E

For dimensions, see section **F**

Single phase induction motors Selection tables

Version "P"

Version "PR"

**SINGLE PHASE INDUCTION MOTORS
WITH SHORT-CIRCUIT ROTOR**

**SINGLE PHASE INDUCTION MOTORS
WITH SHORT-CIRCUIT ROTOR**

STARTING WITH PERMANENT CAPACITOR (PC)

**STARTING WITH PERMANENT CAPACITOR (PC)
AND STARTING CAPACITOR (SC)**

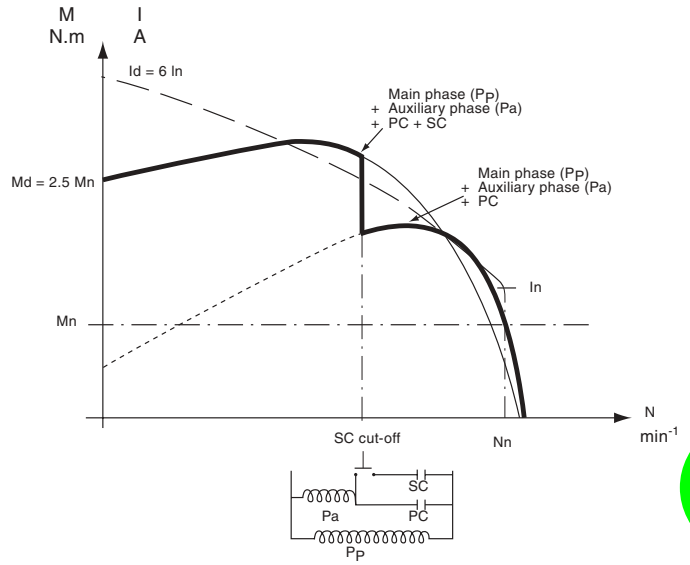
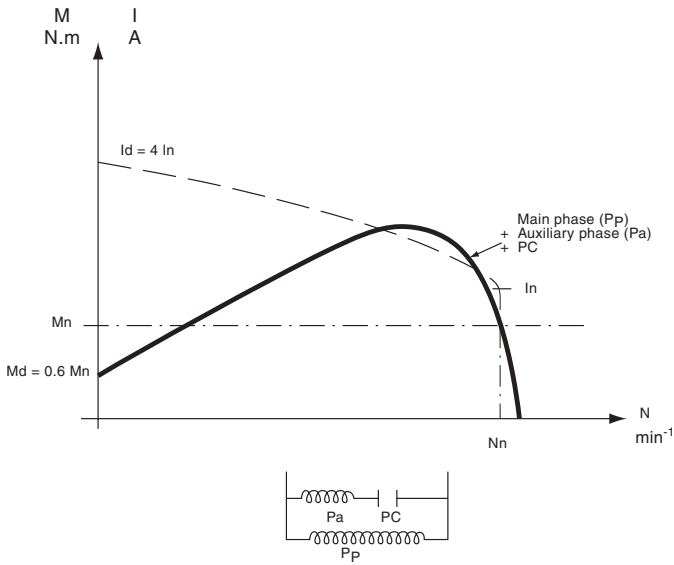

Single phase induction motors Selection tables

E1 - Selection data : SINGLE SPEED

2
Poles
3000 min⁻¹

IP 55 - S1
Cl. F
MULTIVOLTAGE

Type	MAINS SUPPLY 230 V 50 Hz											
	Rated power at 50 Hz	Rated speed	Rated torque	Rated current	Power factor*	Efficiency *	Starting current / Rated current**	Starting torque / Rated torque**	Max. torque / Rated torque	PC 400 V	SC 250 V	Weight
	P_N kW	N_N min ⁻¹	C_N Nm	I_N A	$\cos \varphi$	η %	I_D/I_N	M_D/M_N	M_M/M_N	MF	MF	IM B3 kg
LS 56 P	0.09	2790	0.31	0.90	0.85	50	3.2	0.8	2.4	4	-	3.5
LS 56 P	0.12	2810	0.42	1.15	0.85	54	3.5	0.7	2.4	5	-	4
LS 63 P	0.12	2820	0.42	1.00	0.90	57	4	1	2.5	6	-	4
LS 63 P	0.18	2820	0.61	1.40	0.90	62	4.5	0.9	2.3	8	-	4.5
LS 63 P	0.25	2830	0.84	2.00	0.90	62	4.5	0.9	2.5	10	-	5
LS 71 P	0.25	2780	0.86	1.95	0.90	61	3.5	0.6	2	8	-	5.5
LS 71 P	0.37	2850	1.24	2.70	0.85	70	4.7	0.5	2.3	10	-	7
LS 71 P	0.55	2770	1.90	3.50	0.95	72	4.5	0.6	2.2	16	-	7.5
LS 80 P	0.55	2730	1.93	3.80	0.98	64	4	0.5	2	16	-	8.5
LS 80 P	0.75	2780	2.60	4.85	0.95	70	4.2	0.6	2.2	25	-	9
LS 80 P	1.10	2760	3.80	6.60	0.98	73	4.1	0.5	2	32	-	11
LS 90 P	1.10	2700	3.90	7.50	0.90	73	4.6	0.5	2.2	25	-	14
LS 90 P	1.50	2780	5.15	9.10	0.95	76	4.8	0.7	2.8	50	-	16.5
LS 63 PR	0.18	2900	0.60	1.40	0.85	66	6.3	3.2	2.8	6	30	5
LS 63 PR	0.25	2890	0.83	1.80	0.95	66	6	3	2.6	10	30	5.5
LS 71 PR	0.25	2900	0.83	2.00	0.85	65	5.5	2.4	3	8	30	6
LS 71 PR	0.37	2920	1.20	2.80	0.85	68	6.6	2.3	3.2	12	40	7.5
LS 71 PR	0.55	2900	1.80	3.70	0.85	74	6.6	2.5	2.9	16	60	8
LS 80 PR	0.55	2860	1.83	3.80	0.98	67	5.4	2	2.5	16	60	9
LS 80 PR	0.75	2880	2.50	4.90	0.90	74	6	2.7	2.8	20	100	9.5
LS 80 PR	1.10	2860	3.70	6.60	0.90	77	5.8	1.8	2.6	25	100	11
LS 90 PR	1.50	2860	5.00	8.60	0.98	76	6	2.2	2.4	32	160	14.5
LS 90 PR	1.80	2870	6.00	10.50	0.98	76	6.3	1.9	2.4	40	160	17
LS 100 LPR	2.20	2900	7.50	14.20	0.92	74	6.4	2	2.1	30/450V	200/290V	-
LS 112 MPR	3.00	2870	10.00	16.80	0.98	77	6	1.6	1.8	40/450V	200/290V	-
LS 112 MGPR	4.00	2940	13.20	22.00	0.98	80	6.1	1.4	2.1	60/450V	400/290V	-
LS 132 MPR	5.50	2900	18.70	33.00	0.93	78	5.5	1.9	1.8	60/450V	600/290V	-

Guaranteed Availability of these models.

Single phase induction motors

Selection tables

2
Poles
3600 min⁻¹

Type	SUPPLY 220 V 50 Hz				SUPPLY 240 V 50 Hz			MAINS SUPPLY 230 V 60 Hz							
	Rated power at 50 Hz	Rated speed	Rated current	Power factor*	Rated speed	Rated current	Power factor*	Rated power at 60 Hz	Rated speed	Rated torque	Rated current	Power factor*	Efficiency *	PC 400 V	SC 250 V
	P_N kW	N_N min ⁻¹	I_N A	$\cos \varphi$	N_N min ⁻¹	I_N A	$\cos \varphi$	P_N kW	N_N min ⁻¹	C_N Nm	I_N A	$\cos \varphi$	η %	MF	MF
LS 56 P	0.09	2770	0.85	0.90	2810	1.00	0.80	0.09	3360	0.26	0.80	0.98	52	4	-
LS 56 P	0.12	2790	1.10	0.90	2820	1.25	0.80	0.12	3380	0.34	0.95	0.98	56	5	-
LS 63 P	0.12	2800	1.00	0.95	2830	1.10	0.90	0.12	3370	0.34	1.10	0.98	49	6	-
LS 63 P	0.18	2790	1.45	0.95	2830	1.55	0.85	0.18	3400	0.50	1.35	0.98	59	8	-
LS 63 P	0.25	2790	1.90	0.95	2830	2.10	0.85	0.25	3420	0.70	1.90	0.98	60	10	-
LS 71 P	0.25	2760	1.90	0.95	2800	2.00	0.90	0.25	3340	0.72	1.90	0.98	58	8	-
LS 71 P	0.37	2840	2.60	0.90	2860	2.90	0.80	0.37	3360	1.06	2.60	0.98	66	10	-
LS 71 P	0.55	2750	3.50	0.98	2790	3.80	0.90	0.55	3370	1.57	3.60	0.98	70	16	-
LS 80 P	0.55	2700	4.00	0.98	2770	3.80	0.95	0.55	3310	1.59	3.80	0.98	65	16	-
LS 80 P	0.75	2760	4.90	0.95	2800	5.10	0.90	0.75	3360	2.10	5.00	0.98	66	20	-
LS 80 P	1.10	2750	7.00	0.98	2800	6.90	0.95	1.10	3360	3.13	7.00	0.98	71	25	-
LS 90 P	1.10	2690	7.50	0.90	2750	7.50	0.85	1.10	3340	3.10	7.00	0.98	70	25	-
LS 90 P	1.50	2750	9.50	0.95	2800	9.00	0.90	1.50	3330	4.30	9.00	0.98	73	32	-
LS 63 PR	0.18	2880	1.40	0.90	2900	1.50	0.80	0.18	3470	0.50	1.35	0.98	58	6	30
LS 63 PR	0.25	2870	1.75	0.95	2890	1.95	0.90	0.25	3480	0.68	2.00	0.98	55	10	30
LS 71 PR	0.25	2890	1.85	0.90	2910	2.10	0.80	0.25	3480	0.69	1.80	0.98	63	8	30
LS 71 PR	0.37	2910	2.60	0.90	2920	3.00	0.80	0.37	3510	1.00	2.40	0.98	67	12	40
LS 71 PR	0.55	2890	3.60	0.90	2910	3.90	0.80	0.55	3390	1.55	3.60	0.98	68	16	60
LS 80 PR	0.55	2850	3.80	0.98	2880	3.80	0.90	0.55	3450	1.53	3.60	0.98	67	16	60
LS 80 PR	0.75	2850	5.00	0.95	2880	5.15	0.85	0.75	3480	2.00	4.40	0.98	74	20	100
LS 80 PR	1.10	2850	6.90	0.95	2880	6.50	0.90	1.10	3480	3.00	6.50	0.98	75	25	100
LS 90 PR	1.50	2850	8.90	0.98	2880	8.50	0.95	1.50	3480	4.10	9.00	0.98	75	32	160
LS 90 PR	1.80	2860	11.00	0.98	2880	10.00	0.98	1.80	3450	5.00	11.00	0.98	74	40	160



Single phase induction motors Selection tables

4
Poles
1500 min⁻¹

IP 55 - S1
Cl. F
MULTIVOLTAGE

MAINS SUPPLY 230 V

50 Hz

Type	Rated power at 50 Hz	Rated speed	Rated torque	Rated current	Power factor*	Efficiency *	Starting current / Rated current**	Starting torque / Rated torque**	Max. torque / Rated torque	PC 400 V	SC 250 V	Weight
	P_N kW	N_N min ⁻¹	C_N Nm	I_N A	$\cos \varphi$	η %	I_D/I_N	M_D/M_N	M_M/M_N	MF	MF	IM B3 kg
LS 56 P	0.06	1420	0.40	0.72	0.90	39	2.7	1.3	2.3	6	-	3.5
LS 63 P	0.09	1380	0.62	0.75	0.95	55	2.4	0.7	1.4	6	-	4
LS 63 P	0.12	1400	0.82	1.00	0.95	55	2.9	0.9	1.8	8	-	4.5
LS 63 P	0.18	1370	1.25	1.30	0.95	61	2.7	0.7	1.5	10	-	5
LS 71 P	0.18	1430	1.20	1.80	0.75	57	3.9	0.6	2.6	8	-	6
LS 71 P	0.25	1430	1.66	2.10	0.80	63	4.3	0.6	2.3	10	-	6.5
LS 71 P	0.37	1410	2.50	2.80	0.85	66	4	0.5	1.9	12	-	7.5
LS 80 P	0.37	1340	2.66	2.90	0.85	63	3.1	0.4	1.5	10	-	8
LS 80 P	0.55	1370	3.90	4.20	0.85	67	3.6	0.4	1.6	16	-	8.5
LS 80 P	0.75	1370	5.20	5.40	0.85	69	3.9	0.4	1.7	20	-	10.5
LS 90 P	0.75	1370	5.20	4.80	0.90	72	3.9	0.4	1.7	20	-	14.5
LS 90 P	1.10	1420	7.45	7.00	0.95	71	5	0.6	2.4	40	-	16
LS 63 PR	0.12	1430	0.82	1.05	0.90	57	4.2	2.2	1.9	5	16	5
LS 63 PR	0.18	1410	1.22	1.50	0.85	60	3.7	1.7	1.7	5	16	5.5
LS 71 PR	0.18	1460	1.20	1.70	0.75	59	5	2.7	2.8	8	30	6
LS 71 PR	0.25	1460	1.65	2.20	0.75	66	4.9	2.3	2.5	8	30	7
LS 71 PR	0.37	1440	2.45	2.80	0.85	68	4.7	2.1	2.2	12	40	8
LS 80 PR	0.37	1420	2.45	2.80	0.85	65	4.2	2	1.8	10	40	8.5
LS 80 PR	0.55	1420	3.70	4.20	0.90	65	4.5	1.9	1.9	16	60	9
LS 80 PR	0.75	1430	5.00	5.20	0.85	73	5	2.7	1.9	20	80	10.5
LS 90 PR	0.75	1440	5.00	4.70	0.90	73	5.3	2	2.3	20	80	13
LS 90 PR	1.10	1420	7.36	6.90	0.95	71	4.9	1.9	1.9	25	120	14
LS 90 PR	1.50	1430	10.00	8.60	0.98	76	5.5	1.8	2	40	160	17
LS 100 LPR	2.20	1445	15.00	14.00	0.93	74	5	1.4	1.7	50/450V	200/290V	-
LS 112 MPR	3.00	1430	20.00	19.30	0.90	74	4	1.3	1.6	50/450V	200/290V	-
LS 132 SMPR	4.00	1455	27.00	22.00	0.97	81	7	1.8	2.1	120/450V	600/290V	-
LS 132 MPR	5.50	1455	37.00	33.20	0.90	80	7	1.8	1.8	120/450V	800/290V	-

Guaranteed Availability of these models.

6
Poles
1000 min⁻¹

IP 55 - S1
Cl. F
MULTIVOLTAGE

MAINS SUPPLY 230 V

50 Hz

Type	Rated power at 50 Hz	Rated speed	Rated torque	Rated current	Power factor*	Efficiency *	Starting current / Rated current**	Starting torque / Rated torque**	Max. torque / Rated torque	PC 400 V	SC 250 V	Weight
	P_N kW	N_N min ⁻¹	C_N Nm	I_N A	$\cos \varphi$	η %	I_D/I_N	M_D/M_N	M_M/M_N	MF	MF	IM B3 kg
LS 71 P	0.12	900	1.26	1.00	0.95	52	2.5	0.8	1.4	8	-	7
LS 80 P	0.37	920	3.81	3.00	0.98	53	2.8	0.9	1.9	25	-	10

Guaranteed Availability of these models.

Single phase induction motors

Selection tables

4
Poles
1800 min⁻¹

Type	SUPPLY 220 V 50 Hz				SUPPLY 240 V 50 Hz			MAINS SUPPLY 230 V 60 Hz							
	P_N kW	Rated speed	Rated current	Power factor*	Rated speed	Rated current	Power factor*	P_N kW	Rated speed	Rated torque	Rated current	Power factor*	Efficiency *	PC 400 V	SC 250 V
		N_N min ⁻¹	I_N A	$\cos \varphi$	N_N min ⁻¹	I_N A	$\cos \varphi$		N_N min ⁻¹	C_N Nm	I_N A	$\cos \varphi$	η %	MF	MF
LS 56 P	0.06	1410	0.68	0.95	1420	0.77	0.90	-	-	-	-	-	-	-	-
LS 63 P	0.09	1360	0.75	0.95	1390	0.75	0.95	-	-	-	-	-	-	-	-
LS 63 P	0.12	1390	1.00	0.95	1410	1.00	0.95	0.12	1700	0.70	1.10	0.95	51	8	-
LS 63 P	0.18	1340	1.35	0.95	1380	1.30	0.95	0.18	1660	1.03	1.50	0.98	53	10	-
LS 71 P	0.18	1420	1.70	0.80	1440	2.00	0.75	0.18	1740	1.00	1.35	0.95	59	8	-
LS 71 P	0.25	1420	2.00	0.85	1440	2.20	0.80	0.25	1730	1.40	1.90	0.98	61	10	-
LS 71 P	0.37	1390	2.80	0.85	1420	2.90	0.80	0.37	1700	2.10	2.60	0.98	65	12	-
LS 80 P	0.37	1330	3.05	0.85	1380	2.90	0.80	0.37	1640	2.16	2.60	0.98	64	10	-
LS 80 P	0.55	1360	4.30	0.85	1390	4.30	0.80	0.55	1680	3.10	3.60	0.98	67	16	-
LS 80 P	0.75	1350	5.50	0.85	1380	5.50	0.80	0.75	1690	4.20	4.60	0.98	72	20	-
LS 90 P	0.75	1370	5.00	0.90	1400	4.70	0.90	0.75	1670	4.30	4.80	0.98	70	20	-
LS 90 P	1.10	1410	7.10	0.95	1430	6.90	0.90	1.10	1720	6.10	7.50	0.95	69	40	-
LS 63 PR	0.12	1420	1.05	0.90	1440	1.10	0.85	0.12	1710	0.67	1.00	0.98	52	5	16
LS 63 PR	0.18	1390	1.50	0.90	1420	1.50	0.85	0.18	1690	1.02	1.40	0.9	62	4	16
LS 71 PR	0.18	1450	1.60	0.80	1460	1.90	0.75	0.18	1750	1.00	1.40	0.95	59	8	30
LS 71 PR	0.25	1450	2.10	0.80	1460	2.35	0.70	0.25	1750	1.37	1.80	0.9	68	8	30
LS 71 PR	0.37	1430	2.75	0.85	1450	2.90	0.80	0.37	1730	2.05	2.60	0.98	65	12	40
LS 80 PR	0.37	1410	2.80	0.90	1430	2.90	0.80	0.37	1720	2.00	2.40	0.98	70	10	40
LS 80 PR	0.55	1410	4.20	0.90	1430	4.20	0.85	0.55	1730	3.00	3.40	0.98	72	16	60
LS 80 PR	0.75	1420	5.20	0.90	1440	5.40	0.80	0.75	1730	4.10	4.60	0.98	73	20	80
LS 90 PR	0.75	1430	4.80	0.95	1450	4.95	0.90	0.75	1740	4.10	4.60	0.98	72	20	80
LS 90 PR	1.10	1410	7.2	0.98	1430	6.70	0.95	1.10	1720	6.20	6.50	0.98	74	25	120
LS 90 PR	1.50	1420	9.00	0.98	1440	8.50	0.98	1.50	1740	8.30	8.80	0.95	77	40	160



6
Poles
1200 min⁻¹

Type	SUPPLY 220 V 50 Hz				SUPPLY 240 V 50 Hz			MAINS SUPPLY 230 V 60 Hz							
	P_N kW	Rated speed	Rated current	Power factor*	Rated speed	Rated current	Power factor*	P_N kW	Rated speed	Rated torque	Rated current	Power factor*	Efficiency *	PC 400 V	SC 250 V
		N_N min ⁻¹	I_N A	$\cos \varphi$	N_N min ⁻¹	I_N A	$\cos \varphi$		N_N min ⁻¹	C_N Nm	I_N A	$\cos \varphi$	η %	MF	MF
LS 71 P	0.12	890	0.92	0.98	910	1.00	0.98	0.12	1090	1.05	0.84	0.98	58	6	-
LS 80 P	0.37	910	3.00	0.98	930	3.20	0.98	-	-	-	-	-	-	-	-

Single phase induction motors Dimensions

F1 - Dimensions of shaft extensions

Dimensions in millimetres

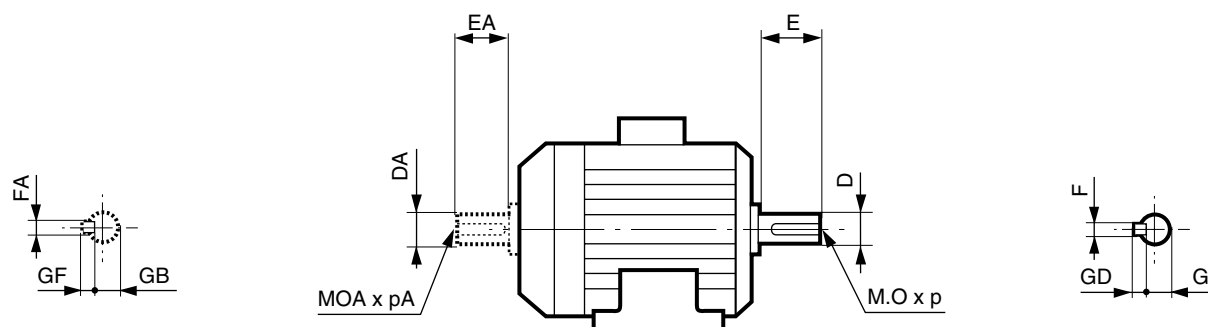

Type	Main shaft extensions						
	2, 4 and 6 poles						
	F	GD	D	E	G	O	p
LS 56	3	3	9j6	20	7	4	10
LS 63	4	4	11j6	23	8.5	4	10
LS 71	5	5	14j6	30	11	5	15
LS 80	6	6	19j6	40	15.5	6	16
LS 90	8	7	24j6	50	20	8	19
LS 100 L PR	8	7	28j6	60	24	10	22
LS 112 M/MG PR	8	7	28j6	60	24	10	22
LS 132 S/M PR	10	8	38k6	80	33	12	28

Type	Secondary shaft extensions						
	2, 4 and 6 poles						
	FA	GF	DA	GB	EA	OA	pA
LS 56	3	3	9j6	7	20	4	10
LS 63	4	4	11j6	8.5	23	4	10
LS 71	5	5	14j6	11	30	5	15
LS 80	5	5	14j6	11	30	5	15
LS 90	6	6	19j6	15.5	40	6	16
LS 100 L PR	8	7	24j6	20	50	8	19
LS 112 M/MG PR	8	7	24j6	20	50	8	19
LS 132 S/M PR	8	7	28j6	24	60	10	22

Single phase induction motors Dimensions

F2 - Foot mounted IM B3 (IM 1001)

Dimensions of LS single phase TEFV induction motors - IP 55 Cage rotor

- foot mounted

Dimensions in millimetres

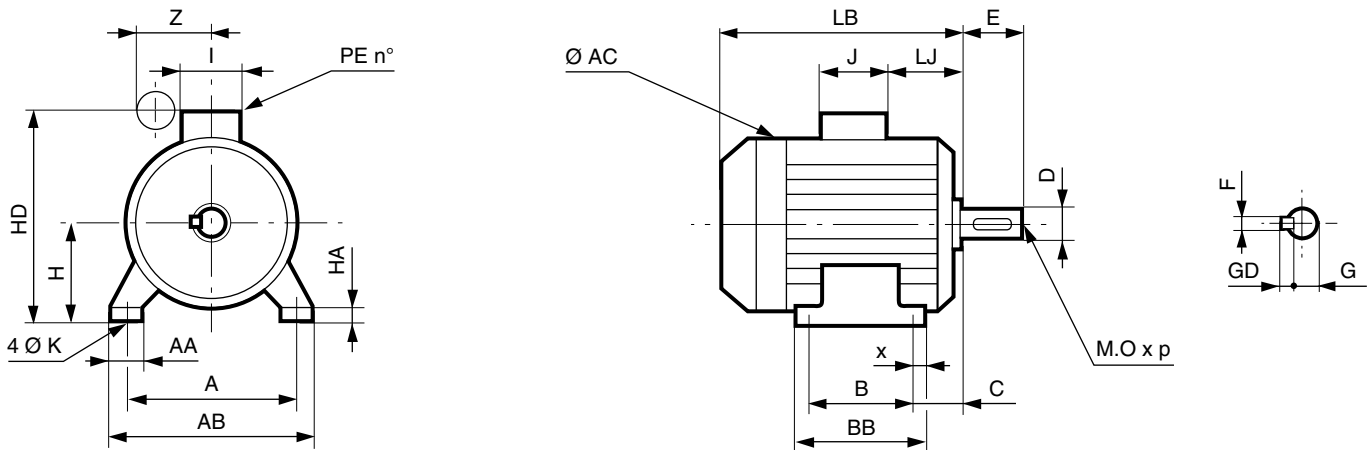

The permanent capacitor is mounted on the outside of the terminal box.
The starting capacitor is located inside the terminal box.

Type	Motors														Shaft extension									
	A	AB	B	BB	C	AA	S	HD	Z max.	H	LJ	HA	x	LB	AC	J	I	F	GD	D	E	G	O	p
LS 56 P	90	104	71	87	36	24	6	148	90	56	8	7	8	156	110	86	88	3	3	9 j6	20	7.2	4	10
LS 63 P ¹	100	115	80	97	40	24.5	7	160	90	63	18	8	8.5	172	126	86	88	4	4	11 j6	23	8.5	4	10
LS 63 PR ¹	100	115	80	97	40	24.5	7	182	100	63	21.5	8	8.5	172	126	138	105	4	4	11 j6	23	8.5	4	10
LS 71 P ²	112	126	90	106	45	23	7	178	90	71	18	9	8	185	140	86	88	5	5	14 j6	30	11	5	12.5
LS 71 PR ²	112	126	90	106	45	23	7	200	100	71	21.5	9	8	185	140	138	105	5	5	14 j6	30	11	5	12.5
LS 80 P	125	157	100	120	50	37	9	201	100	80	24.5	10	10	215	162	86	88	6	6	19 j6	40	15.5	6	15
LS 80 PR	125	157	100	120	50	37	9	223	115	80	24.5	10	10	215	162	138	105	6	6	19 j6	40	15.5	6	15
LS 90 P	140	172	125	162	56	30	9	221	108	90	24.5	11	27.5	245	182	86	88	8	7	24 j6	50	20	8	20
LS 90 PR	140	172	125	162	56	30	9	243	115	90	24.5	11	27.5	245	182	138	105	8	7	24 j6	50	20	8	20
LS 100 LPR	160	196	140	165	63	40	12	259	100	100	26	13	12	290	200	138	104	8	7	28 j6	60	24	10	22
LS 112 MPR	190	220	140	165	70	45	12	271	100	112	26	14	12	290	200	138	104	8	7	28 j6	60	24	10	22
LS 112 MGPR	190	220	140	165	70	52	12	280	140	112	36	14	12	315	235	138	104	8	7	28 j6	60	24	10	22
LS 132 SM/MPR ³	216	250	178	208	89	59	12	307	-	132	25	18	16	387	280	110	130	10	8	38 k6	80	33	12	28

1. LS 63 motors are also fitted with a shaft extension Ø14 x 30 (non-standard).

Motors LS 63 P, 2 P, 0.25 kW and LS 63 P, 4 P, 0.18 kW : change to dimension LB = 187

Motors LS 63 PR, 2 P, 0.25 kW and LS 63 PR, 4 P, 0.18 kW : change to dimension LB = 187

2. Motors LS 71 P, 2 P, 0.55 kW and LS 71 P, 4 P, 0.37 kW : change to dimension LB = 193.

3. Motors supplied with separate electrical cabinet.

- symbol on housing : not identified for frame sizes 56 to 90 mm.

Single phase induction motors Dimensions

F3 - Foot and flange mounted IM B35 (IM 2001)

Dimensions of LS single phase TEFV induction motors - IP 55 Cage rotor

- foot and flange mounted (FF)

Dimensions in millimetres

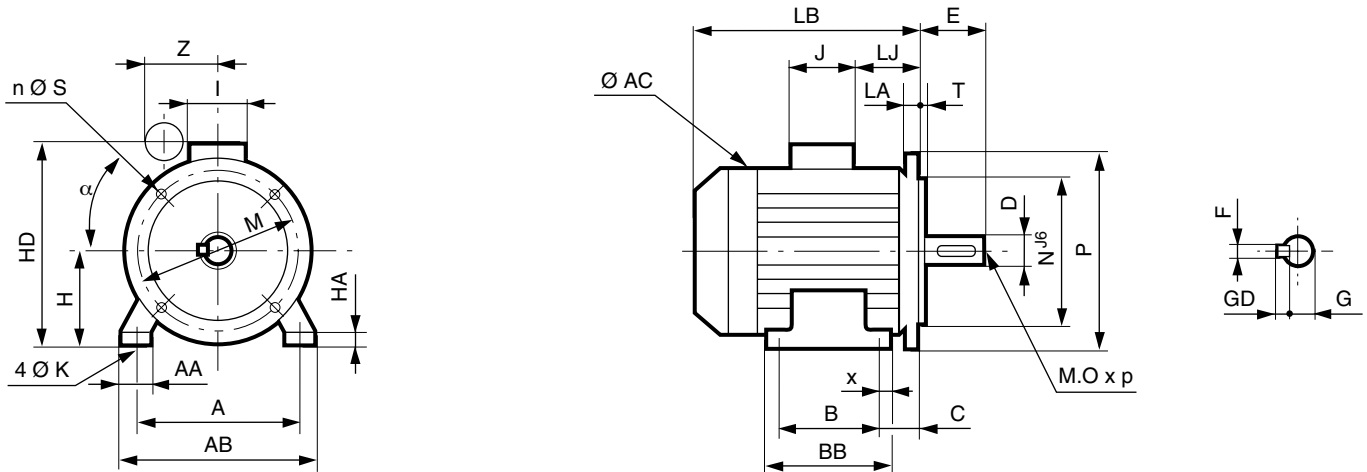

The permanent capacitor is mounted on the outside of the terminal box.
The starting capacitor is located inside the terminal box.



Type	Motors																	
	A	AA	AB	C	B	BB	H	HA	x	HD	K	HJ	Z max	LJ	LB	AC	J	I
LS 56 P	90	24	104	36	71	87	56	7	8	148	6	92	90	8	156	110	86	88
LS 63 P ¹	100	24.5	115	40	80	97	63	8	8.5	160	7	97	90	18	172	126	86	88
LS 63 PR ¹	100	24.5	115	40	80	97	63	8	8.5	182	7	119	100	21.5	172	126	138	105
LS 71 P ²	112	23	126	45	90	106	71	9	8	178	7	107	90	18	185	140	86	88
LS 71 PR ²	112	23	126	45	90	106	71	9	8	200	7	129	100	21.5	185	140	138	105
LS 80 P	125	37	157	50	100	120	80	10	10	201	9	121	100	24.5	215	162	86	88
LS 80 PR	125	37	157	50	100	120	80	10	10	223	9	143	115	24.5	215	162	138	105
LS 90 P	140	30	172	56	125	162	90	11	27.5	221	9	131	108	24.5	265	182	86	88
LS 90 PR	140	30	172	56	125	162	90	11	27.5	243	9	153	115	24.5	265	182	138	105
LS 100 LPR	160	40	196	63	140	165	100	13	12	259	12	159	100	26	290	200	138	104
LS 112 MPR	190	45	220	70	140	165	112	14	12	271	12	159	100	26	290	200	138	104
LS 112 MGPR	190	52	220	70	140	165	112	14	12	280	12	168	140	36	315	235	138	104
LS 132 SM/MPR ³	216	59	250	89	178	208	132	18	16	307	12	175	-	25	387	280	110	130

1. LS 63 motors are also fitted with a shaft extension $\varnothing 14 \times 30$ (non-standard).

Motors LS 63 P, 2 P, 0.25 kW and LS 63 P, 4 P, 0.18 kW : change to dimension LB = 187

Motors LS 63 PR, 2 P, 0.25 kW and LS 63 PR, 4 P, 0.18 kW : change to dimension LB = 187

2. Motors LS 71 P, 2 P, 0.55 kW and LS 71 P, 4 P, 0.37 kW : change to dimension LB = 193.

3. Motors supplied with separate electrical cabinet.

Single phase induction motors Dimensions

F4 - Flange mounted IM B5 (IM 3001)

Dimensions of LS single phase TEFV induction motors - IP 55 Cage rotor

- flange mounted (FF)

Dimensions in millimetres

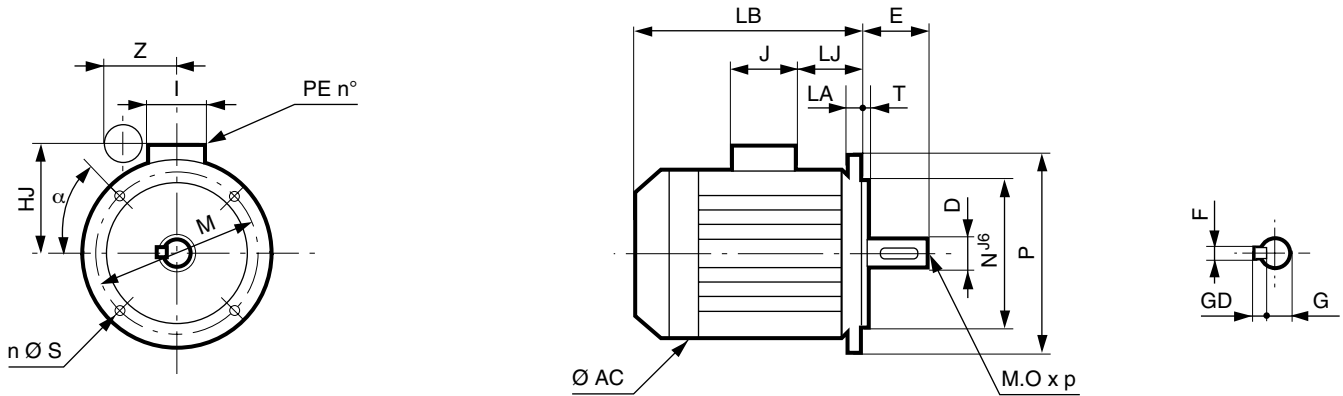

The permanent capacitor is mounted on the outside of the terminal box.
The starting capacitor is located inside the terminal box.

Type	Symb.	Flanges							Shaft extension						
		M	N	P	LA	α	T	S	F	GD	D	E	G	O	p
LS 56 P	FF 100	100	80	120	8	45°	3	7	3	3	9 j6	20	7.2	4	10
LS 63 P ¹	FF 115	115	95	140	10	45°	3	9	4	4	11 j6	23	8.5	4	10
LS 63 PR ¹	FF 115	115	95	140	10	45°	3	9	4	4	11 j6	23	8.5	4	10
LS 71 P ²	FF 130	130	110	160	8	45°	3.5	9	5	5	14 j6	30	11	5	12.5
LS 71 PR ²	FF 130	130	110	160	8	45°	3.5	9	5	5	14 j6	30	11	5	12.5
LS 80 P	FF 165	165	130	200	10	45°	3.5	11	6	6	19 j6	40	15.5	6	15
LS 80 PR	FF 165	165	130	200	10	45°	3.5	11	6	6	19 j6	40	15.5	6	15
LS 90 P	FF 165	165	130	200	10	45°	3.5	11	8	7	24 j6	50	20	8	20
LS 90 PR	FF 165	165	130	200	10	45°	3.5	11	8	7	24 j6	50	20	8	20
LS 100 LPR	FF 215	215	180	250	12	45°	4	14.5	8	7	28 j6	60	24	10	22
LS 112 MPR	FF 215	215	180	250	12	45°	4	14.5	8	7	28 j6	60	24	10	22
LS 112 MGPR	FF 215	215	180	250	12	45°	4	14.5	8	7	28 j6	60	24	10	22
LS 132 SM/MPR ³	FF 265	265	230	300	14	45°	4	14.5	10	8	38 k6	80	33	12	28

1. LS 63 motors are also fitted with a shaft extension Ø14 x 30 (non-standard).

Motors LS 63 P, 2 P, 0.25 kW and LS 63 P, 4 P, 0.18 kW : change to dimension LB = 187

Motors LS 63 PR, 2 P, 0.25 kW and LS 63 PR, 4 P, 0.18 kW : change to dimension LB = 187

2. Motors LS 71 P, 2 P, 0.55 kW and LS 71 P, 4 P, 0.37 kW : change to dimension LB = 193.

3. Motors supplied with separate electrical cabinet.

Single phase induction motors Dimensions

F5 - Foot and face mounted IM B34 (IM 2101)

Dimensions of LS single phase TEFV induction motors - IP 55 Cage rotor

- foot and face mounted (FT)

Dimensions in millimetres

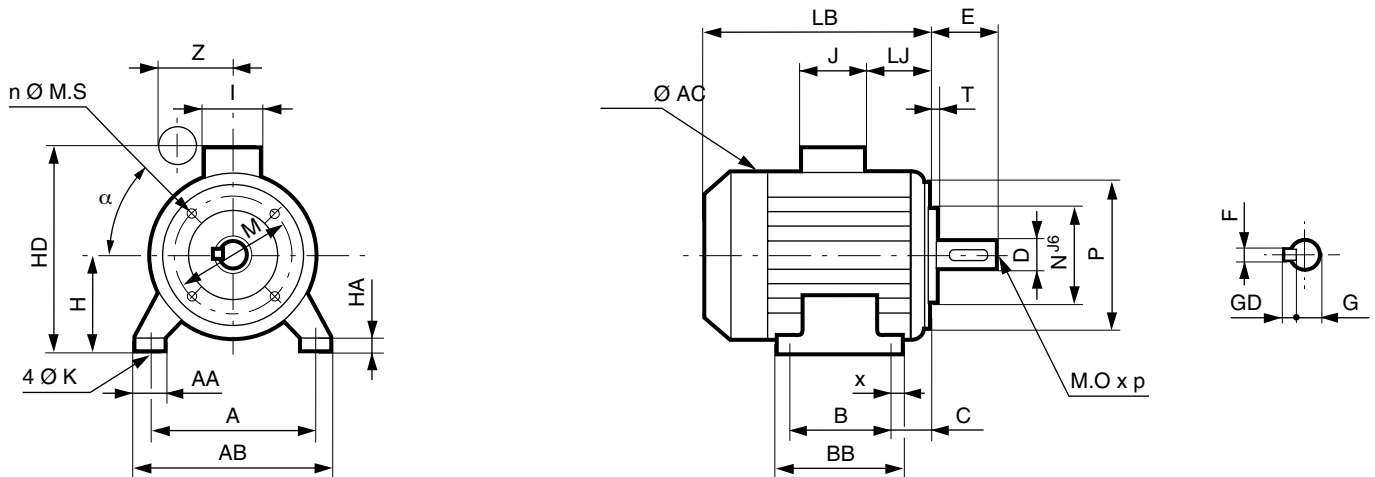

The permanent capacitor is mounted on the outside of the terminal box.
The starting capacitor is located inside the terminal box.



Type	Motors																
	A	AA	AB	B	BB	H	HA	x	HD	K	HJ	Z max	LJ	LB	AC	J	I
LS 56 P	90	24	104	71	87	56	7	8	148	6	92	90	8	156	110	86	88
LS 63 P ¹	100	24.5	115	80	97	63	8	8.5	160	7	97	90	18	172	126	86	88
LS 63 PR ¹	100	24.5	115	80	97	63	8	8.5	182	7	119	100	21.5	172	126	138	105
LS 71 P ²	112	23	126	90	106	71	9	8	178	7	107	90	18	185	140	86	88
LS 71 PR ²	112	23	126	90	106	71	9	8	200	7	128	100	21.5	185	140	138	105
LS 80 P	125	37	157	100	120	80	10	10	201	9	121	100	24.5	215	162	86	88
LS 80 PR	125	37	157	100	120	80	10	10	223	9	143	115	24.5	215	162	138	105
LS 90 P	140	30	172	125	162	90	11	27.5	221	9	131	108	24.5	245	182	86	88
LS 90 PR	140	30	172	125	162	90	11	27.5	243	9	153	115	24.5	245	182	138	105
LS 100 LPR	160	40	196	140	165	100	13	12	259	12	159	100	26	290	200	138	104
LS 112 MPR	190	45	220	140	165	112	14	12	271	12	159	100	26	290	200	138	104
LS 112 MGPR	190	52	220	140	165	112	14	12	280	12	168	140	36	315	235	138	104
LS 132 SM/MPR ³	216	59	250	178	208	132	18	16	307	12	175	-	25	387	280	110	130

1. LS 63 motors are also fitted with a shaft extension Ø14 x 30 (non-standard).

Motors LS 63 P, 2 P, 0.25 kW and LS 63 P, 4 P, 0.18 kW : change to dimension LB = 187

Motors LS 63 PR, 2 P, 0.25 kW and LS 63 PR, 4 P, 0.18 kW : change to dimension LB = 187

2. Motors LS 71 P, 2 P, 0.55 kW and LS 71 P, 4 P, 0.37 kW : change to dimension LB = 193.

3. Motors supplied with separate electrical cabinet.

Single phase induction motors Dimensions

F6 - Face mounted IM B14 (IM 3601)

Dimensions of LS single phase TEFV induction motors - IP 55 Cage rotor

- face mounted (FT)

Dimensions in millimetres

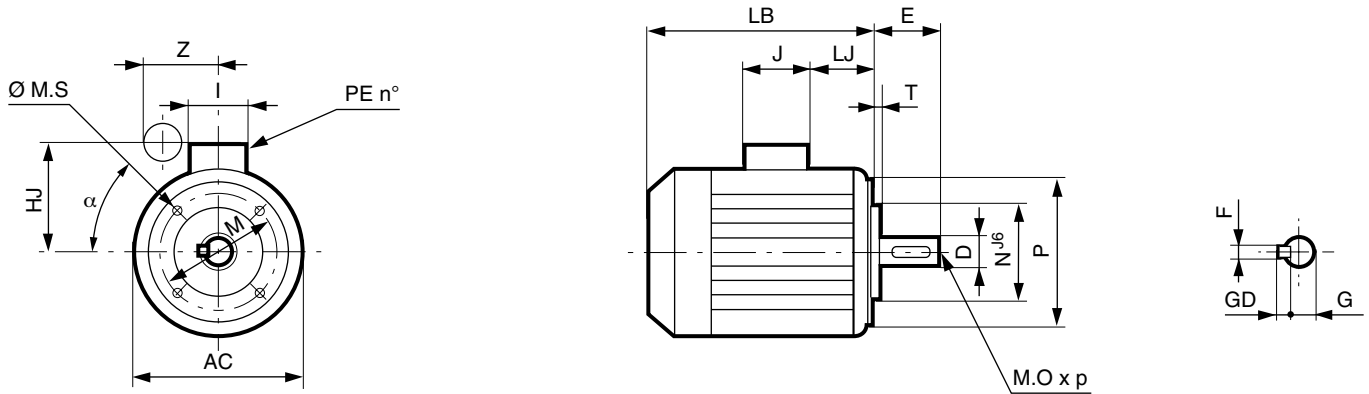

The permanent capacitor is mounted on the outside of the terminal box.
The starting capacitor is located inside the terminal box.

Type	Symb.	Flanges						Shaft extension						
		M	N	P	α	T	M-S	F	GD	D	E	G	O	p
LS 56 P	FT 65	65	50	80	45°	2.5	5	3	3	9 j6	20	7.2	4	10
LS 63 P ¹	FT 75	75	60	90	45°	2.5	5	4	4	11 j6	23	8.5	4	10
LS 63 PR ¹	FT 75	75	60	90	45°	2.5	5	4	4	11 j6	23	8.5	4	10
LS 71 P ²	FT 85	85	70	105	45°	2.5	6	5	5	14 j6	30	11	5	12.5
LS 71 PR ²	FT 85	85	70	105	45°	2.5	6	5	5	14 j6	30	11	5	12.5
LS 80 P	FT 100	100	80	120	45°	3	6	6	6	19 j6	40	15.5	6	15
LS 80 PR	FT 100	100	80	120	45°	3	6	6	6	19 j6	40	15.5	6	15
LS 90 P	FT 115	115	95	140	45°	3	8	8	7	24 j6	50	20	8	20
LS 90 PR	FT 115	115	95	140	45°	3	8	8	7	24 j6	50	20	8	20
LS 100 LPR	FT 130	130	110	160	45°	3.5	8	8	7	28 j6	6	24	10	22
LS 112 MPR	FT 130	130	110	160	45°	3.5	8	8	7	28 j6	6	24	10	22
LS 112 MGPR	FT 130	130	110	160	45°	3.5	8	8	7	28 j6	60	24	10	22
LS 132 SM/MPR ³	FT 215	215	180	250	45°	4	10	10	8	38 k6	80	33	12	28

- LS 63 motors are also fitted with a shaft extension $\varnothing 14 \times 30$ (non-standard).
Motors LS 63 P, 2 P, 0.25 kW and LS 63 P, 4 P, 0.18 kW : change to dimension $LB = 187$
Motors LS 63 PR, 2 P, 0.25 kW and LS 63 PR, 4 P, 0.18 kW : change to dimension $LB = 187$
- Motors LS 71 P, 2 P, 0.55 kW and LS 71 P, 4 P, 0.37 kW : change to dimension $LB = 193$.
- Motors supplied with separate electrical cabinet.

F7 - Electrical cabinet for LS 132

Dimensions in millimetres

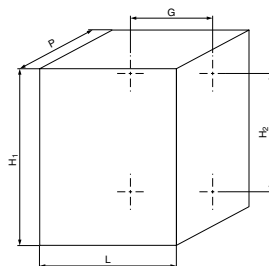

L	P	H1	H2	G	Max. weight in kg
250	150	400	325	175	12

Single phase induction motors

Optional features

G1 - Non-standard flanges

Optionally, LEROY-SOMER motors can be fitted with flanges and faceplates that are larger or smaller than standard. This means that motors can be adapted to all types of situation without the need for costly and time-consuming modifications.

The tables below give flange and faceplate dimensions and flange/motor compatibility. The bearing and shaft extension for each frame size remain standard.

MAIN FLANGE DIMENSIONS

Flange mounted (FF)

Dimensions in millimetres

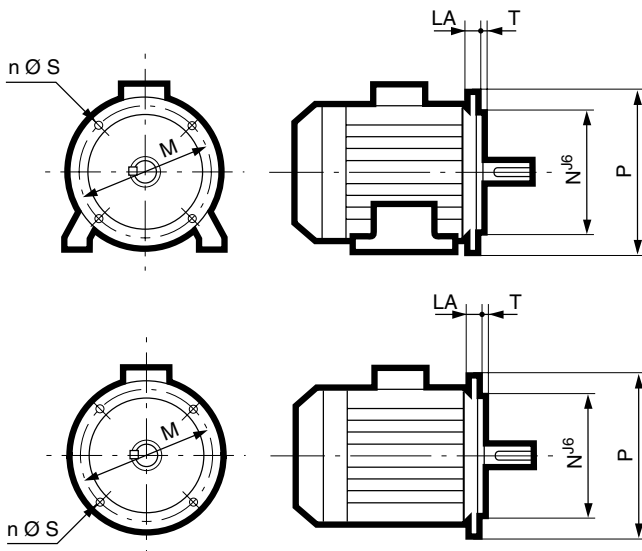

IEC symbol	Flange dimensions						
	M	N	P	T	n	S	LA
FF 100	100	80	120	3	4	7	5
FF 115	115	95	140	3	4	10	10
FF 130	130	110	160	3.5	4	10	10
FF 165	165	130	200	3.5	4	12	10
FF 215	215	180	250	4	4	14.5	12
FF 265	265	230	300	4	4	14.5	14
FF 300	300	250	350	5	4	18.5	14

Face mounted (FT)

Dimensions in millimetres

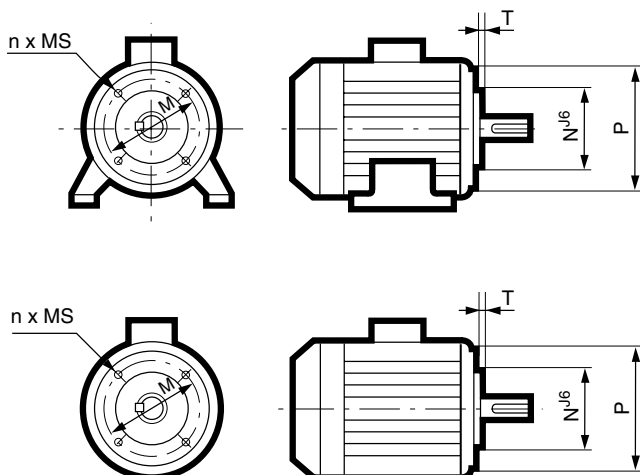

IEC symbol	Flange dimensions					
	M	N	P	T	n	M.S
FT 65	65	50	80	2.5	4	M5
FT 75	75	60	90	2.5	4	M5
FT 85	85	70	105	2.5	4	M6
FT 100	100	80	120	3	4	M6
FT 115	115	95	140	3	4	M8
FT 130	130	110	160	3.5	4	M8
FT 165	165	130	200	3.5	4	M10
FT 215	215	180	250	4	4	M12
FT 265	265	230	300	4	4	M12

Single phase induction motors

Optional features

Flange mounted (FF)

Flange type \ Motor type	FF 100	FF 115	FF 130	FF 165	FF 215	FF 265	FF 300
LS 56	●						
LS 63	○	●	*				
LS 71	○	○	●	*			
LS 80		○	○	●	*		
LS 90		*	*	●	*		
LS 90 (feet)		○	○	○	○		
LS 100		○	○	○	●		
LS 112		○	○	○	●		
LS 112 MG			○	○	●	*	
LS 132 SMM				○	○	●	○

● Standard B3

○ Modified bearing location

* Adaptable without modification

Face mounted (FT)

Motor type	FT 65	FT 75	FT 85	FT 100	FT 115	FT 130	FT 165	FT 215	FT 265
LS 56	●	*	*	*					
LS 63	*	●	*	*	*				
LS 71	*	*	●	*	*	*			
LS 80			*	●	*	*	*		
LS 90				*	●	*	○		
LS 90 (feet)				*	●	*	○		
LS 100					*	●	*	*	
LS 112					*	●	*	*	
LS 112 MG					*	●	*	*	
LS 132 SMM							*	●	*

G2 - Drip covers

Dimensions in millimetres

Drip cover for vertical operation, shaft facing down

Type	LB' = LB +	Ø
56	20	115
63	20	125
71	20	140
80	20	145
90	20	185
100	20	185
112	20	185
112 MG	25	210
132	30	240

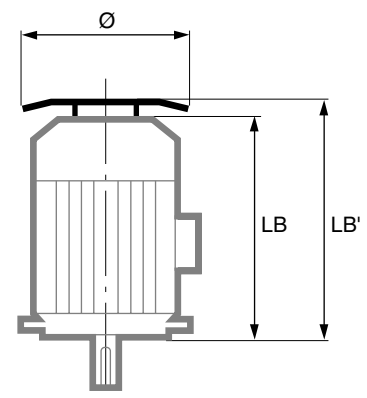

Single phase induction motors Installation and maintenance

H1 - Voltage drop along cables (standard NFC 15100)

Voltage drops are calculated using the formula:

$$u = b \left(\rho_l \frac{L}{S} \cos \varphi + \lambda L \sin \varphi \right) I_s$$

where

u = voltage drop,

b = factor equal to 2 for single phase circuits

ρ_l = resistivity of the conductors in normal duty, taken as being equal to the resistivity at the normal duty temperature, i.e. 1.25 times the resistivity at 20° C, giving 0.0225 $\Omega\text{mm}^2/\text{m}$ for copper and 0.036 $\Omega\text{mm}^2/\text{m}$ for aluminium.

L = length of cabling conduits in metres

S = cross-section of conductors in mm^2

$\cos \varphi$ = Power Factor: if the exact figure is not available, the PF is taken as being 0.8 ($\sin \varphi = 0.6$)

λ = linear reactance of conductors, taken as being equal to 0.08 $\text{m}\Omega/\text{m}$ if the exact figure is not available.

I_s = current in use, in amps.

The higher the current, the greater the voltage drop will be. The voltage drop should therefore be calculated for the starting current to see if this is suitable for the application. If the most important criterion is the starting torque (or the starting time), the voltage drop will have to be limited to 3% maximum* (the equivalent of a loss of torque of 6 to 8%).

* the relative voltage drop (as a %) equals :

$$\Delta u = 100 \frac{u}{U_0}$$

U_0 = voltage between phase and neutral

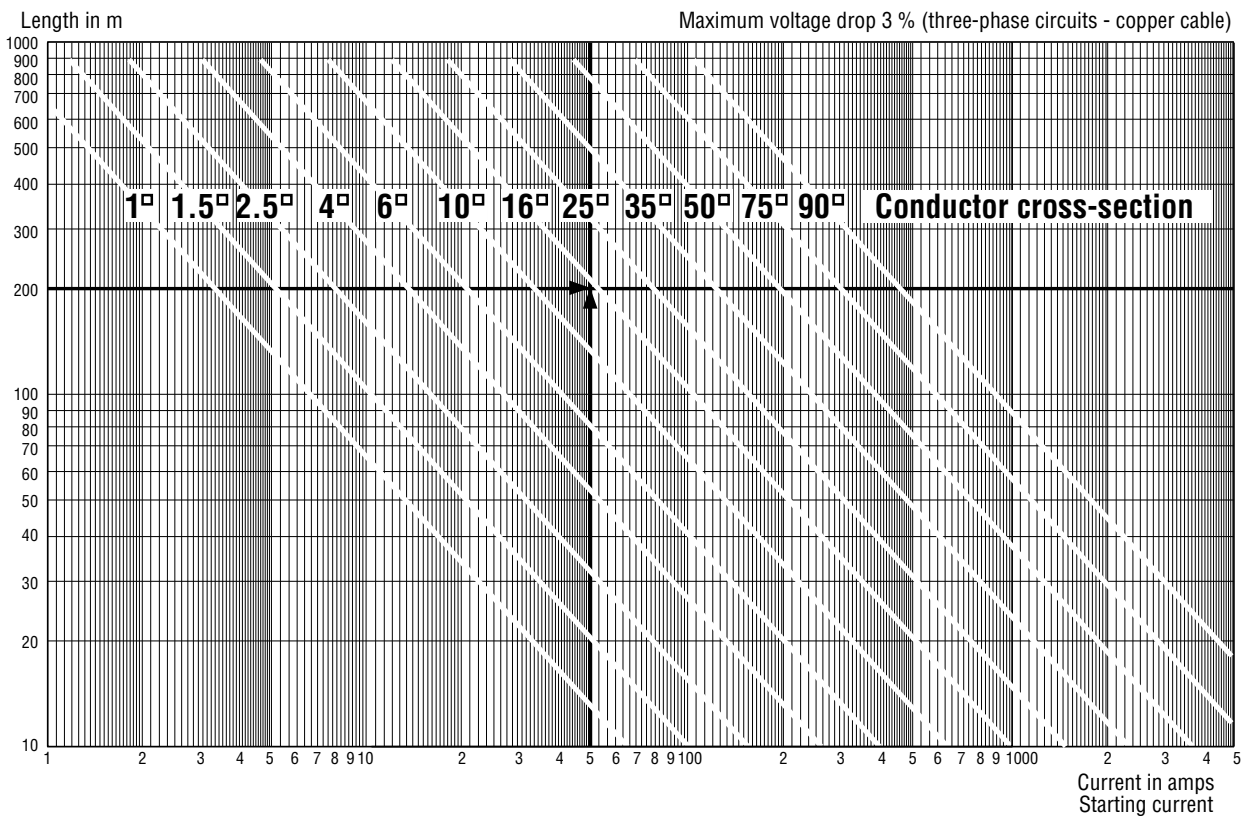

Maximum power for D.O.L. motors

The table opposite shows maximum kW ratings for D.O.L. motors connected to the mains supply.

Minimizing starting trouble

For the installation to remain in good working order, it is necessary to avoid any more than minimal temperature rise in the cable conduits, while making sure that the protection devices do not interrupt starting. Operating problems in other equipment connected to the same supply are caused by the current demand on starting, which can be many times heavier than the current absorbed at full load and speed.

▼ Maximum power for D.O.L. motors (kW)

Motor type	Single phase 230 (220) V
Type of premises	
Domestic	1.4
Other premises } overhead power lines	3
} underground power lines	5.5

"Other premises" includes the service sector, industry, agriculture, etc.

For motors with high inertia, long starting times, direction change by current reversal and brake motors, the electricity supply company must carry out all the necessary checks before installation.

Single phase induction motors Installation and maintenance

H2 - Packaging weights and dimensions

Dimensions in millimetres

Frame size	ROAD TRANSPORT			
	IM B3		IM B5 - IM V1	
	Tare (kg)	Dimensions in mm (L x W x H)	Tare (kg)	Dimensions in mm (L x W x H)
<i>Cardboard boxes</i>				
56	0.3	230 x 120 x 170	0.3	230 x 120 x 170
63	0.3	230 x 120 x 170	0.3	230 x 120 x 170
71	0.4	305 x 155 x 170	0.4	305 x 155 x 170
80	0.7	320 x 200 x 240	0.7	320 x 200 x 240
90	0.85	365 x 200 x 265	0.85	300 x 200 x 265
100	1.4	430 x 255 x 310	1.4	430 x 255 x 310
112	1.4	430 x 255 x 310	1.4	430 x 255 x 310
132	2.5	535 x 305 x 362	2.5	535 x 305 x 362

Frame size	SEA TRANSPORT			
	IM B3		IM B5 - IM V1	
	Tare (kg)	Dimensions in mm (L x W x H)	Tare (kg)	Dimensions in mm (L x W x H)
<i>Plywood crates</i>				
56	on request		on request	
63	on request		on request	
71	on request		on request	
80	on request		on request	
90	on request		on request	
100	21	740 x 480 x 610	24	740 x 480 x 610
112	21	740 x 480 x 610	24	740 x 480 x 610
132	21	740 x 480 x 610	24	740 x 480 x 610

- These values are given for individual packages
- Frame sizes up to 132 grouped in cardboard containers on a standard 1200 x 800 pallet

Single phase induction motors Installation and maintenance

H3 - Position of lifting rings

Position of lifting rings for lifting the motor only (not connected to the machine)

Labour regulations in France stipulate that all loads above 25 kg should be fitted with lifting devices to facilitate handling.

The positions of the lifting rings and the minimum dimensions of the loading bars are given below in order to help with preparation for handling the motors. Without these precautions, there is a risk of warping or crushing certain items, such as the terminal boxes, protective cover and drip cover.

IMPORTANT : motors intended for use in the vertical position may be delivered in the horizontal position on a pallet. When the motor is pivoted, under no circumstances should the shaft be allowed to touch the ground, or the bearings may be irreparably damaged.

• Horizontal position

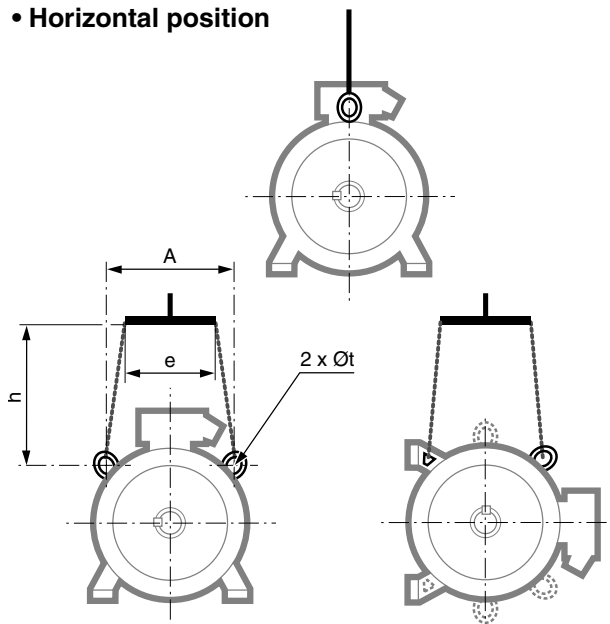





Type	Horizontal position			
	A	e min	h min	Øt
100	120	200	150	9
112	120	200	150	9
132	160	200	150	9



Single phase induction motors Installation and maintenance

H4 - Identification, exploded views and parts list

H4.1 - IDENTIFICATION PLATES

*  LERROY SOMER		~ 1 LS90PR			
IP 55 I K 07		N° 902382-1999			
		cl. F 40 °C		17 kg	
S 1	%	c/h	C P	40 μF	400 V
		C D	160 μF	250 V	
	V	Hz	min⁻¹	kW	Cosφ
	220	50	2860	1.8	.95
	230	50	2870	1.8	.95
	240	50	2880	1.8	.95
				A	
					11
					10.5
					10
					GQ000100

product marking

The fact that motors conform to the essential requirements of the Directives is shown by the  mark on their nameplates and/or packaging and documentation.

* Other logos may be used as an option, but only by agreement BEFORE ordering.

▼ Explanation of symbols used on identification plates

Frame size < 100

 Legal mark indicating that the equipment conforms to the requirements of the European Directives.

MOT 1 ~ : Single phase A.C. motor
LS : Range
90 : Frame size
PR : Starting mode
T : Impregnation index

Motor no.

902382 : Serial number
1999 : Year of production

kg : Weight
IP55 IK08 : Index of protection
(I) cl. F : Insulation class F
40°C : Contractual ambient operating temperature
S : Duty
% : Duty (operating) factor
c/h : Number of cycles per hour
V : Supply voltage
Hz : Supply frequency
min⁻¹ : Revolutions per minute (RPM)
kW : Rated output power
cos φ : Power factor
A : Rated current

CP : Permanent capacitor
CD : Starting capacitor



Please quote when ordering spare parts.

Single phase induction motors Installation and maintenance

H4 - Identification, exploded views and parts list

H4.2 - FRAME SIZE : 56 to 132

Version "P" with permanent capacitor

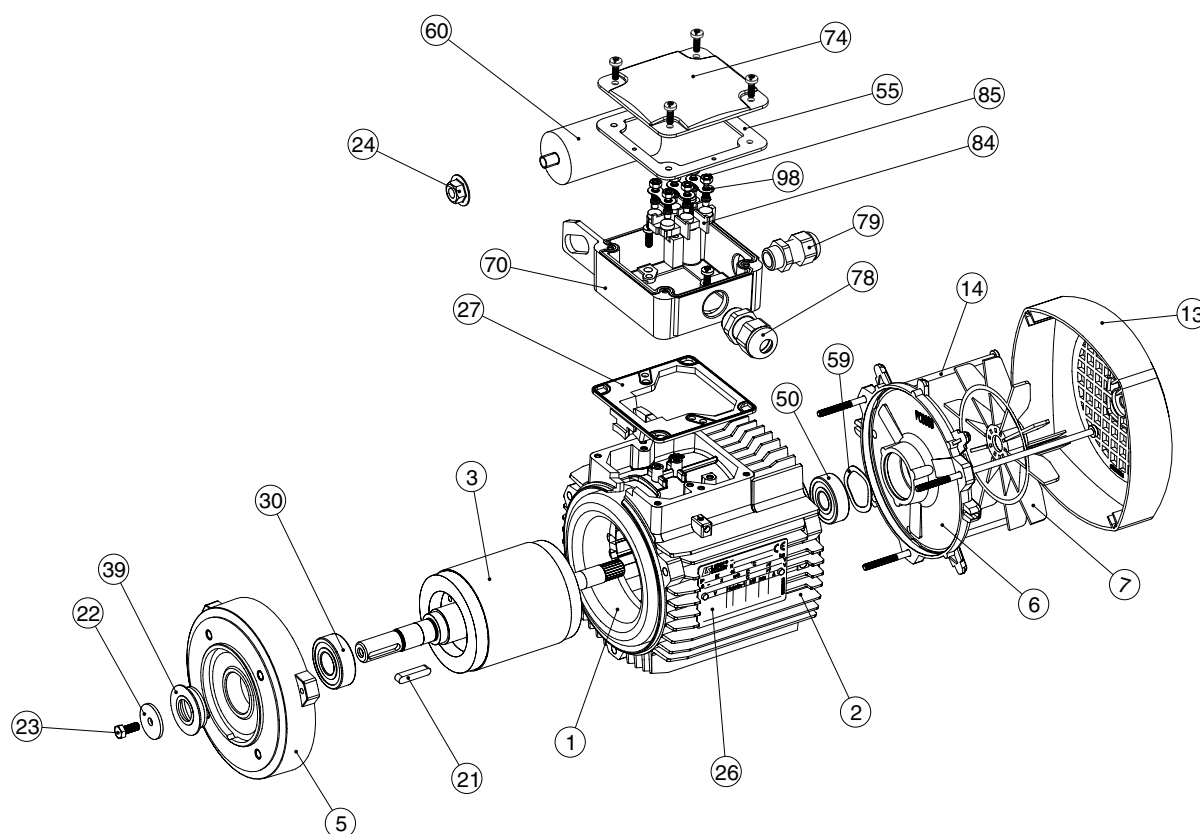

Frame size : 56 to 132

No.	Description	No.	Description	No.	Description
1	Wound stator	22	Shaft end washer	59	Preloading (wavy) washer
2	Housing	23	Shaft end screw	60	Permanent capacitor
3	Rotor	24	Capacitor nut	70	Terminal box
5	Drive end shield	26	Identification plate	74	Terminal box cover
6	Non drive end shield	27	Base seal	78	Power supply cable gland
7	Fan	30	Drive end bearing	79	Capacitor cable gland
13	Fan cover	39	Drive end seal	84	Terminal block
14	Tie rods	50	Non drive end bearing	85	Set screw
21	Shaft extension key	55	Cover seal	98	Connecting bars

Single phase induction motors Installation and maintenance

H4 - Identification, exploded views and parts list

H4.3 - FRAME SIZE : 56 to 132

Version "PR" with permanent capacitor and starting capacitor

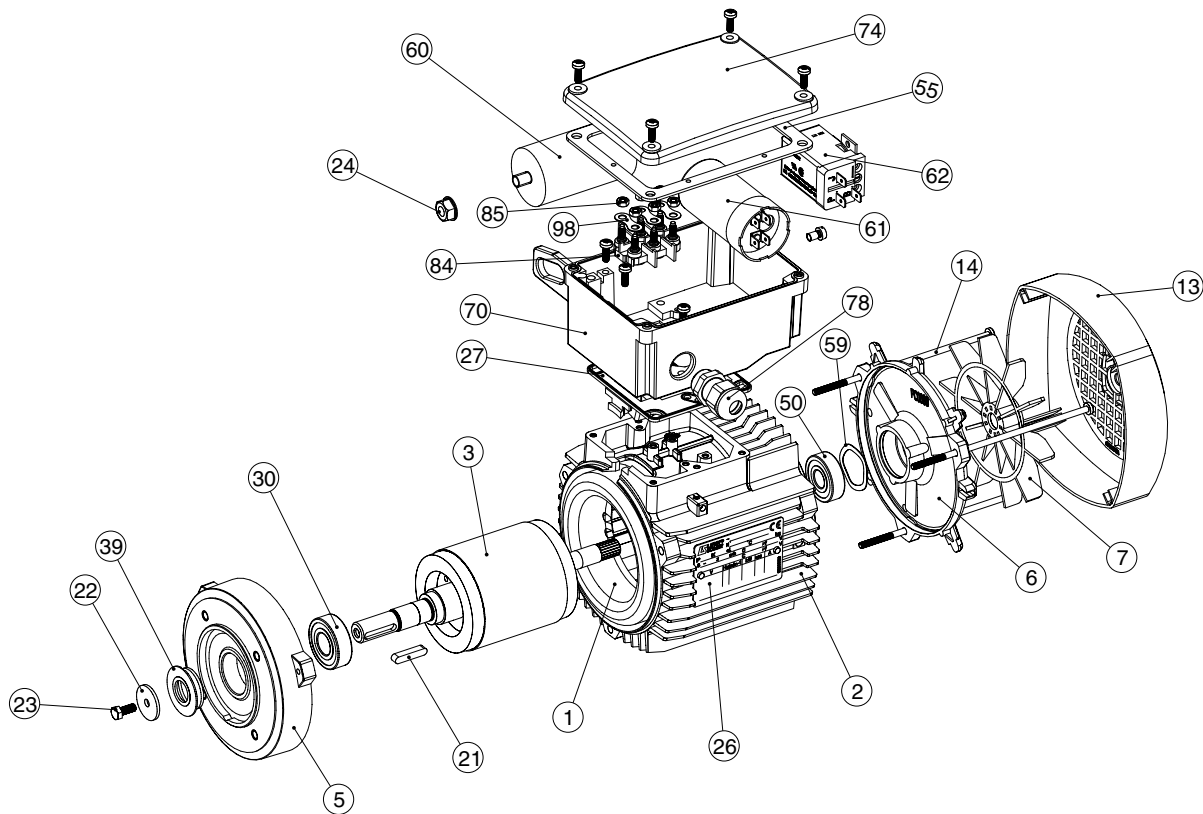

Frame size : 56 to 132

No.	Description	No.	Description	No.	Description
1	Wound stator	23	Shaft end screw	61	Starting capacitor
2	Housing	24	Capacitor nut	62	Voltage relay
3	Rotor	26	Identification plate	70	Terminal box
5	Drive end shield	27	Base seal	74	Terminal box cover
6	Non drive end shield	30	Drive end bearing	78	Power supply cable gland
7	Fan	39	Drive end seal	84	Terminal block
13	Fan cover	50	Non drive end bearing	85	Set screw
14	Tie rods	55	Cover seal	98	Connecting bars
21	Shaft extension key	59	Preloading (wavy) washer		
22	Shaft end washer	60	Permanent capacitor		



Variable speed motors

With a single phase power supply $230\text{ V} \pm 10\%$ 50/60 Hz, it is possible to control the acceleration or speed of rotation of a motor which would not then itself be powered by a single phase supply.



1.1 Integrated variable speed : VARMECA

The drive is supplied with single phase current and is integrated in a special terminal box. It is fixed on a 3-phase A.C. motor connected as 3-phase 230 V 50 Hz (delta).

Characteristics :

- Power : 0.25 to 0.37 kW
- Speed (4 poles) : 320 to 2250 min^{-1}
- Constant torque
- $\text{Cos } \varphi$ around 1



1.2 Separate drive

1.2.1 With induction motor : FMV 1107

The drive is supplied with single phase current, and should be integrated in a cubicle (not supplied). It can be used to control a 3-phase A.C. motor connected as 3-phase 230 V 50 Hz (delta).

Characteristics :

- Power : 0.18 kW to 0.37 kW
- Speed (4 poles) : 285 to 2850 min^{-1}
- Constant torque
- $\text{Cos } \varphi$ around 1



1.2.2 With D.C. motor : MVE

The drive is supplied with single phase current. It can be used to control a motor supplied with 190 V DC - 3000 min^{-1} .

Characteristics :

- Power : 0.075 to 0.37 kW
- Speed : 200 to 3000 min^{-1}
- Constant torque
- $\text{Cos } \varphi$ around 1



Control of electrical machines

The tests which are most commonly recommended by the various standards relating to control of electrical equipment concern measurements of dielectric strength, insulation, continuity of the ground circuit, discharge time and leakage current. With test values varying from one standard to another, it is impossible to be aware of them all. The new "machinery" directive EN 60201-1 regulates the safety of "industrial machines", both new and installed. It is also helpful in that it imposes tests which are fully representative of those recommended for all electrical equipment in general.

THE DIELECTRIC TEST

The test for dielectric strength is used to check the quality of the machine insulation system.

* Measurement method

Voltage should be applied between the conductors and the PE circuit (earth). The test should be performed using twice the rated voltage, with a minimum of 1000 V + 20 %, at 500 VA, for 1 second.

THE INSULATION TEST

Checking the quality of the insulation between live parts and those which are not live gives the opportunity to monitor progressive ageing of the equipment and gives early warning of possible faults.

* Measurement method

The measurement is taken between the power circuit conductors and the earth circuit. At a voltage of 500 V DC, the insulation resistance should be 1 M Ω minimum.

THE CONTINUITY TEST

Fault currents should run away easily to earth. The continuity measurement checks that the earth circuit resistance is sufficiently low to ensure effective protection.

* Measurement method

The check is performed between the PE terminal (end of the earth cable) and the various points of the earth circuit. The voltage drop with a current of at least 10 A AC for more than 10 seconds, should not exceed certain thresholds, depending on the earth conductor cross-section : 3.3 V for a 1 mm² cross-section; 2.6 V for 1.5 mm²; 1.9 V for 2.5 mm² ; etc.

MEASUREMENT OF THE DISCHARGE TIME

After deliberate or accidental disconnection of the machine power supply, it should not have dangerous voltage levels at its accessible parts (eg : power supply terminals) or on its internal parts. This measurement is used to check that the machine "discharges" correctly.

* Measurement method

When a break in supply is detected, the time for sufficient discharge is counted. This should be effective (U < 60 V) in less than 1 second for accessible parts, and 5 seconds for internal parts.



Single phase induction motors Installation and maintenance

H5 - Maintenance

LEROY-SOMER can provide installation and maintenance information on each type of product or product range.

These documents, plus other technical information on our products are obtainable from LEROY-SOMER sales offices.

When asking for informative material, you should quote the full reference of the machine.

LEROY-SOMER, in its continuous search for ways to help our customers, has evaluated numerous methods of preventive maintenance.

The diagram and table below give the recommended equipment to use and the ideal positions on the motor to take measurements of all parameters which can affect the operation of the machine, such as eccentricity, vibration, winding insulation, etc.

This system allows the user both to monitor the performance of the equipment during use, and, in the event of a fault to give measurements which will allow LEROY-SOMER to analyse and diagnose the causes quickly and efficiently, ensuring the minimum downtime.

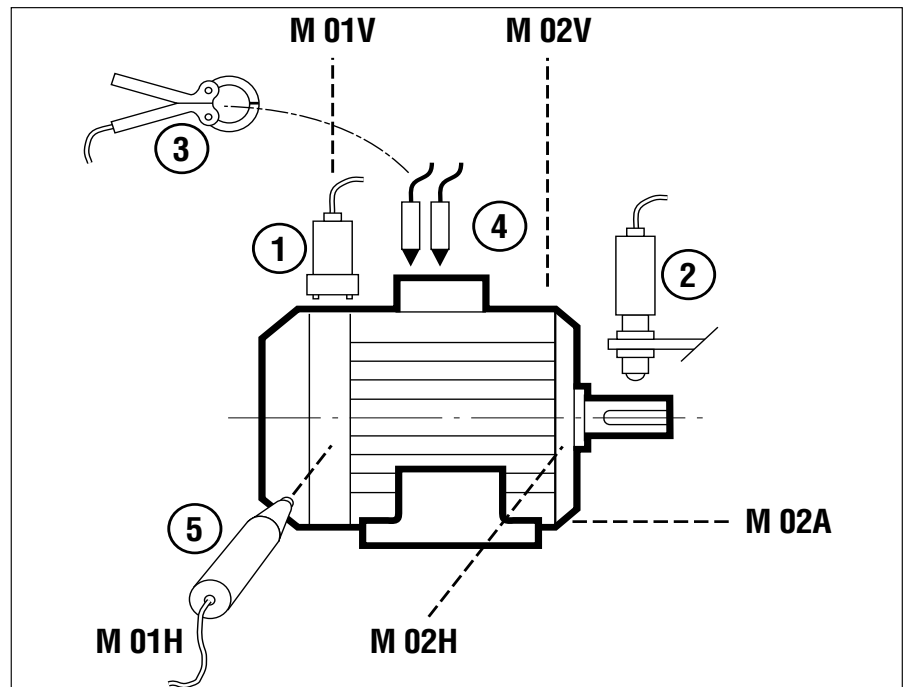

Measuring device	Measurement points									
	M 01V	M 01H	M 02V	M 02H	M 02A	Shaft	E01	E02	E03	E04
① Accelerometer : for measuring vibrations	●	●	●	●	●					
② Photo-electric cell : for measuring speed and phase (balancing)						●				
③ Clamp Ammeter : for measuring current (D.C. & 3-phase A.C.)							●	●	●	
④ Voltage probe : A.C. & D.C. voltages							●	●	●	
⑤ Infra-red probe : for measuring temperature	●		●							
⑥ Capacitance meter : for checking state of capacitors										●



General sales conditions

I - APPLICATION AREA

Acceptance of our tenders or the placing of any order with us implies acceptance of the following conditions without exception or reservation. These conditions of sale shall prevail over all stipulations appearing on the customer's purchase order, his general conditions of purchase or any other document emanating from him and / or a third party.

A dispensation from these General Conditions of Sale applies to sales concerning foundry parts, which are subject to the European Foundries General Conditions of Sale, latest edition.

II - ORDERS

All orders, including those taken by our agents and representatives, by whatever mode of transmission, become valid only after we have accepted them in writing.

We reserve the right to modify the characteristics of our goods without prior warning.

However, the customer reserves the possibility to specify technical specifications in the order.

Unless such requirements have been notified in writing, the customer will not be able to refuse delivery of new modified goods.

Our company will not accept responsibility for an incorrect choice of goods if this incorrect choice results from incomplete and / or erroneous conditions of use, or conditions that have not been conveyed to the vendor by the customer.

Unless otherwise specified, our tenders and estimates are only valid for thirty days from the date of issue.

When the goods have to satisfy standards, particular regulations and / or be inspected by standards or control organisations, the price request must be accompanied by full specifications with which we must comply with. This is mentioned in the estimate. All test and inspection fees are the customer's responsibility.

III - PRICE

Our prices and price lists are shown exclusive of tax and may be revised without prior notice.

Our prices are either firm for the duration specified on the estimate, or subject to revision according to a formula accompanying the tender which, depending on the regulations, covers a change in the cost of raw materials, products, various services and salaries, an index of which is published in the B.O.C.C.R.F. ("Bulletin Officiel de la Concurrence, de la Consommation et de la Répression des Fraudes").

For any order of goods not found in our catalogue, requiring special manufacture, the invoice will include a minimum fixed sum of 600 FRF (six hundred French Francs) exclusive of tax, to cover start - up costs. Any tax due will be charged to the customer.

All related costs, such as customs clearance and special inspections, will be added on.

Customers should remember that the French Franc (or other currency) is being replaced by the Single European Currency (EURO) according to a European Community ruling. In accordance with the general principles of monetary law, references to the French Franc will then as of right be considered to refer to the Euro. This substitution will be enforced on the date and in accordance with the conditions defined by the European Community ruling.

IV - DELIVERY

Our export sales are governed by the INCOTERMS published by the International Chamber of Commerce ("I.C.C. INCOTERMS"), latest edition.

Goods are despatched in accordance with the conditions indicated on our order acknowledgement, sent out in response to any order for goods and / or services.

Unless otherwise specified, our prices refer to goods put at customer's disposal in our factories, and include standard packaging.

Unless otherwise specified, goods are always transported at the consignee's risk. Without exception, it is up to the purchaser to raise with the transporter, in the legal form and time limits, any claim concerning the condition or the number of packages received and also to send us at the same time a copy of this declaration. Failure to respect this procedure will relieve us of all responsibility.

In the case of CIF (Cost, Insurance & Freight) or CIP (Carriage & Insurance Paid to) sales, etc., in the event of damage, our responsibility will only be engaged if any reservations and required declarations have been notified in the required time period, and will not in any case exceed the indemnity sum received from our insurers.

If the arrangements for despatch are modified, we reserve the right to invoice any additional costs arising from such changes. Packages cannot be returned.

Should the delivery of goods be delayed for a reason not attributable to the vendor, goods will be stored on the vendor's premises, at the own risk of the customer, at a charge for storage of 1% (one per cent) of the total order sum per week, beginning, without a grace period, on the day after the scheduled date of delivery indicated in the contract. After thirty days from this date, the vendor has the right to dispose of these goods as he wishes and arrange a new delivery date for the said goods with the customer. In all instances, all down payments received remain the property of the vendor as indemnity, without prejudice to other claims for damages that the vendor may wish to bring.

V - DELIVERY DATES

Delivery times are stated for information only, and do not include the month of August.

Delivery dates are counted from the issue date of the order acknowledgement from the vendor and are subject to compliance with the provisions indicated on the order acknowledgement, notably receipt of the down payment for the order, notification of the issuance of an irrevocable letter of credit conforming to all vendor requirements (especially as regards the amount, currency, validity, licence, etc...) and acceptance of the terms of payment with any guarantees which may be required, etc...

In no case does late delivery automatically entitle the customer to damages and / or penalties.

Unless otherwise specified, we reserve the right to make partial deliveries.

Delivery dates are automatically suspended without formal notice, and the vendor shall have no responsibility in cases of Force Majeure, or events beyond the control of the vendor or his suppliers such as delays, saturation, or unavailability of the

planned transport methods, energy, raw materials etc..., serious accidents such as fires, explosions, strikes, lock out, or emergency measures taken by the Authorities occurring after the conclusion of the order and preventing its normal execution. Similarly, delivery dates are automatically suspended without formal notice in all cases of failure to perform or late payment by the customer.

VI - TESTS

All goods manufactured by the vendor are tested before leaving the factory in accordance with vendor's ISO 9001 certifications. Customers may attend these tests : they simply have to convey the wish to do so in writing when the order is placed.

Specific tests and acceptance tests requested by the customer, whether conducted on the customer's premises, in our factories, on-site, or by inspection organisations, must be noted on the order and are to be paid for by the customer.

Goods specially developed for a customer will have to be approved by the latter before any delivery of mass - produced goods, notified by signing and returning to us the Product Approval Schedule reference Q1 T. 034.

In the event of the customer's insistence on delivery without having signed this form beforehand, the goods will then still be considered as prototypes and the customer will assume sole responsibility for using it or supplying it to his own customers.

VII - TERMS OF PAYMENT

All our sales are considered as carried out and payable at the registered office of the vendor, without exception, whatever the method of payment, the place of conclusion of the sale and delivery.

When the customer is based in France, our invoices are payable on receipt in cash, by banker's draft, or by L.C.R. ("Lettre de Change - Relevé"), within thirty days from the end of the month following the invoice date, net and without discount.

When the customer is based outside France, our invoices are payable in cash against delivery of the dispatching documents or by irrevocable documentary credit confirmed by a first class French bank with all bank charges payable by the customer.

Payments must be made in the currency of the invoice.

In accordance with French Law N° 92.1442 dated December 31.1992, non-payment of an invoice by its due date will give rise, after formal notice, to a penalty equal to one and a half times (1.5) the official rate of interest, and to late payment interest at the bank base rate plus five per cent. If the invoice carries V.A.T. (Value Added Tax), this is calculated on the amount, inclusive of tax, of the remaining sum due and comes into force from the due date.

Should steps have to be taken to recover the said amount, a surcharge of 15% (fifteen per cent) of the sum demanded will be payable.

Moreover, as a consequence of non - payment of an invoice or any term of payment, whatever the method of payment envisaged, the customer shall pay immediately for the whole of the outstanding amount owed to the vendor (including his subsidiaries, sister or parent companies,

whether in France or overseas) for all deliveries or services, whatever their initial due date.

Notwithstanding any particular terms of payment arranged between the parties concerned, the vendor reserves the right to demand :

- payment in cash, before the goods leave the factory, for all orders in the process of manufacture, in the event of a problem with payment, or if the customer's financial situation justifies it,

- a down payment for the order.

Unless we are at fault, all down payments are non - returnable, without prejudice to our right to claim damages.

Any payment made in advance of the fixed payment date will lead to a discount of 0.2 % (zero point two per cent) per month of the amount concerned.

VIII - COMPENSATION CLAUSE

Unless prohibited by law, the vendor and the customer expressly agree between one another to compensate their respective debts arising from their commercial relationship, even if the conditions defined by law for legal compensation are not all satisfied.

In applying this clause, by vendor we mean any company in the LEROY SOMER group.

IX - TRANSFER OF RISKS - TRANSFERT OF TITLE

Transfer of risks occurs upon the handing over of the goods, according to the delivery conditions agreed at the time of ordering.

THE TRANSFER OF TITLE OF THE GOODS SOLD TO THE CUSTOMER OCCURS UPON PAYMENT OF THE WHOLE PRINCIPAL SUM AND INTEREST.

The provision of a document creating an obligation to pay (bank draft or similar) does not constitute payment.

So long as the price has not been paid in full, the customer is obliged to inform the vendor, within twenty - four hours, of the seizure, requisition or confiscation of goods to the benefit of a third party, and to take all safety measures to acquaint others with and respect our right of title in the event of intervention by creditors.

Failure to pay the amount due, whether total or partial, on the due date, for whatever reason and on whatever grounds, authorises the vendor to demand as of right and without formal notice, the return of the goods, wherever they may be, at the customer's expense and risk.

Return of the goods does not imply to cancellation of the sale. However, we reserve the option to apply the cancellation clause contained in these General Conditions of Sale.

X - CONFIDENTIALITY

The vendor and the customer undertake to maintain confidentiality of information of a technical, commercial or other nature, obtained during negotiations and / or the execution of any order.

XI - INDUSTRIAL AND INTELLECTUAL PROPERTY RIGHTS

The results, data, studies and information (whether patentable or not), or software developed by the vendor during execution of any order, and delivered to the customer, are the sole property of the vendor.

Apart from the instructions for use, servicing and maintenance,

reports and documents of any type that we deliver to our customers remain our property and must be returned to us on request, even when design fees have been charged for them, and they shall not be communicated to third parties or used without the prior written agreement of the vendor.

XII - CANCELLATION CLAUSE

We reserve the right to cancel immediately, as of right and without formal notice, the sale of our goods in case of non-payment of any part of the price by the due date, or in case of any breach in the contractual obligations of the customer. In this case, the goods will have to be returned to us immediately, at the customer's own risk and expense, subject to a penalty of 10% (ten per cent) of its value per week of delay. All payments already received shall remain our property as indemnity, without prejudice to our rights to claim damages.

XIII - WARRANTY

The vendor warrants the goods against any defect, arising from a default in material or in workmanship, for twelve months starting from the date on which they are made available, according to the conditions defined below.

The warranty for goods with special applications, or goods used 24 hours a day, is automatically reduced by half.

On the other hand, parts or accessories of other origin, which bear their own brand name, are included in our warranty only to the extent of the warranty conditions granted by the suppliers of these parts.

The vendor's warranty will only apply insofar as the goods have been stored, used and maintained in accordance with the vendor's instructions and documentation. It cannot be invoked when the default results from :

- failure to monitor, maintain or store the goods correctly,
- normal wear and tear of goods,
- intervention on or modification to the goods without the vendor's prior authorisation in writing,
- abnormal use, or use not conforming to the intended purpose,
- defective installation at the customer's and / or the final user's premises,
- non-communication, by the customer, of the intended purpose or the conditions of use of the goods,
- failure to use original manufacturer's spare parts,
- Force Majeure or any event beyond the control of the vendor,
- etc ...

In all cases, the warranty is limited to the replacement or the repair of parts or goods recognised as defective by our technical departments. If the repair is entrusted to a third party, it should only be carried out after acceptance by the vendor of the estimate for repair.

No goods should be returned without the vendor's prior authorisation in writing.

Goods to be repaired should be sent prepaid, to the address indicated by the vendor. If the goods have not been repaired under warranty, the cost of dispatching it back will be invoiced to the customer or to the end purchaser.

This warranty applies to our goods in accessible form and therefore does not cover the cost of dismantling and reinstallation of the said goods in the equipment in which they are integrated. Repair, modification, or replacement of spare parts or goods during the warranty period will not extend the duration of the warranty.

The provisions of this article constitute the only obligation on the part of the vendor concerning the warranty for the goods supplied.

XIV - LIABILITY

The vendor will be liable for bodily injury caused by his goods or personnel.

The repair of property damages attributable to the vendor is expressly limited to a sum which may not exceed the amount of the goods found as defective.

It is expressly agreed that the vendor and the customer each waive any right to claim for indirect, consequential and / or punitive damages of any kind, such as loss of production, loss of profit, costs of withdrawal from the market or costs of recall, costs of dismantling and reinstallation of goods, loss of contracts, etc ...

XV - SPARE PARTS AND ACCESSORIES

Spare parts and accessories are provided on request insofar as they are available. Related costs (carriage and any other costs) are always added to the invoice.

We reserve the right to demand a minimum quantity or invoice a minimum per order.

XVI - PARTIAL INVALIDITY

If any provision of these General Conditions of Sale is held to be unenforceable for any reason, it shall be adjusted rather than voided, if possible, in order to achieve the intent of the parties to the extent possible. In any event, all other provisions shall be deemed valid and enforceable to the full extent possible.

XVII - DISPUTES

THESE GENERAL CONDITIONS OF SALE ARE GOVERNED BY FRENCH LAW.

ANY DISPUTE RELATING TO OUR SALES, EVEN IN THE CASE OF MULTIPLE DEFENDANTS, SHALL BE, IN THE ABSENCE OF AMICABLE SETTLEMENT AND NOTWITHSTANDING ANY CLAUSE TO THE CONTRARY, SUBJECT TO THE JURISDICTION OF THE COURTS OF ANGOULEME (France).

Notes

Notes

Notes



DRIVE SYSTEMS
ELECTRICAL MOTORS - GEARBOXES - ELECTRONICS

ENERGY
ALTERNATORS - ASYNCHRONOUS & D.C. GENERATORS



**European leader
in industrial
drive systems**

**World leader
in alternators**

WORLDWIDE PRESENCE
34 PRODUCTION UNITS / 470 SALES & SERVICE CENTERS WORLDWIDE

MOTEURS LEROY-SOMER - Boulevard Marcellin Leroy - 16015 ANGOULEME Cédex - FRANCE
Phone +33 545 64 45 64 - Fax +33 545 64 45 04



MOTEURS LEROY-SOMER 16015 ANGOULÊME CEDEX-FRANCE